



OPERATING MANUAL



English



ALADIN[®] SPORT PLUS
SWISS MADE BY UWATEC AG

Operating scheme

Operating scheme for surface functions



B and E



B and +



B and -

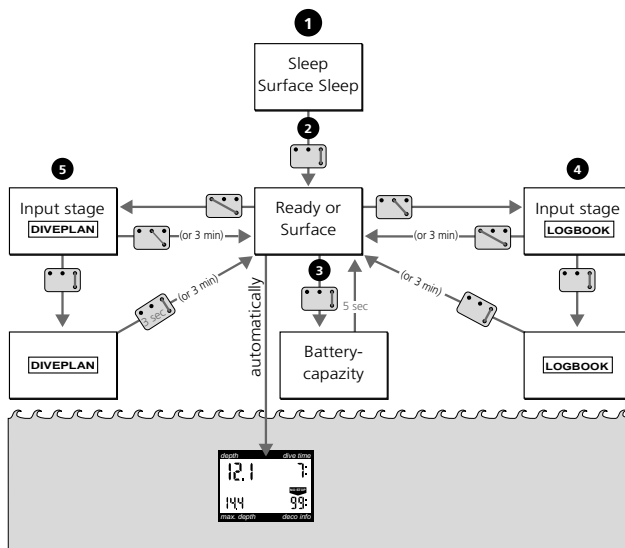

Important remarks concerning signal words and symbols

This operating manual makes use of the following icons to indicate especially important comments:

Remarks:



Informations and tips which are important for optimal use of the functions of your Aladin® Sport Plus.

Attention!



Information which draws your attention to situations and special features important for your diving comfort and the early avoidance of risk situations.

Danger!



Alarms which indicate risk situations and dangers. Ignoring these warnings can lead to situations involving danger to life and limb. These alarms must be obeyed!

The following symbols are used in the operating manual:



Flashing display



Operating instruction for manual input
Example: bridging contacts B and E

Safety considerations

You must carefully read and understand this entire manual before using your Aladin® Sport Plus.



Diving has many inherent risks. Decompression sickness is among the most serious of those risks. Even if you follow the instructions of this manual in a careful manner, it is still possible that you may be seriously injured or die from decompression sickness or some other inherent risk of scuba diving. Unless you are fully aware of these risks and are willing to personally accept and assume responsibility for those risks, do not use the Aladin® Sport Plus!

The Aladin® Sport Plus is a sophisticated dive computer to assist a trained and certified diver in making decisions concerning dive planning and execution. As with any tool, the Aladin® Sport Plus may be misused if the following safety and operational precautions are not strictly followed. If they are followed, careful use of the Aladin® Sport Plus can increase your diving enjoyment and reduce your risk of decompression sickness. If they are not, you will be placing yourself at serious risk for decompression sickness. While the Aladin® Sport Plus is a technically advanced tool based on a mathematical model of decompression sickness, neither it nor any other diving computer (or table) can exactly monitor the physiological changes that occur in your body as you dive. In addition, each diver will vary in his or her susceptibility to decompression sickness. In addition, each diver will vary in his or her susceptibility to decompression sickness. In addition to this, each individual diver's own susceptibility may vary from day to day. Combined with the fact that decompression modelling is an inexact science, and must be based to some extent on certain unproven assumptions, it is emphasis on you, the individual diver, to dive responsibly and to carefully follow all standard safe diving practices as well as the recommendations contained in this manual.

Guidelines for the use of Aladin® Sport Plus:

The following guidelines for using Aladin® Sport Plus are derived from the latest medical research for diving with diving computers. Following these guidelines will greatly increase your safety while diving, but cannot guarantee that decompression sickness will not occur.

- The Aladin® Sport Plus is designed for dives made with compressed air only. Do not use the Aladin® Sport Plus for dives made with nitrox or other mixed gases.
- Due to the danger of nitrogen narcosis do not dive deeper than 40 m. Aladin® Sport Plus does not warn you in this respect.

Safety considerations

- On all dives with the Aladin® Sport Plus, make a safety stop for at least one to three minutes within the 3 to 5 metre zone.
- Always make the deepest dive of the day first when repetitive dives are planned, and for each dive make sure that the deepest portion of that dive is done at the beginning of the dive.
- All divers using dive computers to plan dives and indicate or determine decompression status must use their own computer which they take with them on all dives.
- If the Aladin® Sport Plus fails at any time during the dive, the dive must be terminated, and appropriate surfacing procedures should be initiated immediately.
- On any given dive, all divers in a buddy group must follow the most conservative dive computer for that particular dive.
- Repetitive dives after exchanging the dive computer: Wait at least 24 hour before you start with the repetitive dive.
- Always observe the optical alarm signals of the Aladin® Sport Plus. Avoid situations of increased risk for decompression sickness which are marked with a warning sign in this operating manual.
- The decompression algorithm contained in the Aladin® Sport Plus only serves for emergency or unintended decompression.
- You **MUST** follow the ascent rates as indicated by the Aladin® Sport Plus and if the computer should fail for any reason, you must ascend at a rate of no greater than 10 metres per minute.
- You **MUST** be familiar with all signs and symptoms of decompression sickness before using the Aladin® Sport Plus! Seek **IMMEDIATE** treatment for decompression sickness should any of these signs or symptoms occur after a dive! There is a direct correlation between the effectiveness of treatment and the delay between the onset of symptoms and the treatment for decompression sickness.
- See also page 10-11, 40-41, 65.

Aladin® Sport Plus – The Diving System

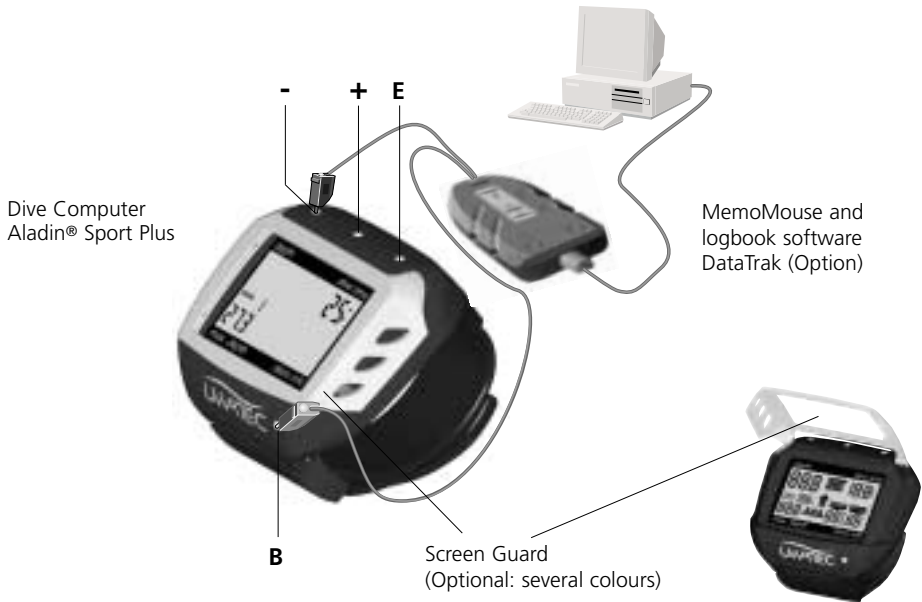

List of chapters

I Aladin® Sport Plus – Introduction	9	5 Functions at the Surface	35
1 Aladin® Sport Plus – Safe No-Stop Diving	10	5.1 End of a dive	35
2 Aladin® Sport Plus – Your Personal Companion	10	5.2 Desaturation time	36
3 The Calculation Model ZH-L8 ADT		5.3 No fly time	36
3.1 Description	12	5.4 Warning of bubbles	37
3.2 Advantages	13	6 Diving in Mountain Lakes	37
4 Safety in Diving	14		
II Aladin® Sport Plus – Survey	15	IV Diving at Reduced Risk with Aladin® Sport Plus	39
1 Aladin® Sport Plus System	16	1 Diving at Reduced Risk with Aladin® Sport Plus	
2 Operation	17	1.1 Diving at reduced risk	40
2.1 Operating for surface functions	17	1.2 Diving at reduced risk for the first dive	40
Switching on display	17	1.3 Minimizing risk on repetitive dives	41
Switching off display	17	1.4 Response in increased risk situation	42
Active backlight	18		
2.3 Operating modes	22	V Logbook	45
III Diving with Aladin® Sport Plus	27	1 Survey	46
1 Terminology/Symbols	28	2 Selection and Activation	47
2 Attention Messages and Alarms	29	3 Selection of Dive	48
2.1 Attention messages	29	4 Leaving the Logbook-Mode	49
2.2 Alarms	30	5 Output on PC	50
2.3 Alarm low battery	30	VI Dive Planner	51
3 Preparation for the Dive	31	1 Survey	52
4 Functions during the Dive	32	2 Selection and Activation from Ready-Mode	52
4.1 Dive time	32	3 Selection and Activation from Surface-Mode	53
4.2 Current depth	32	4 Planning a No-Stop Dive	54
4.3 Maximum depth	32	5 Leaving the Diveplan-Mode	56
4.4 Ascent rate	33		
4.5 Decompression information	34		

VII	Communication Software for Windows®	57
1	MemoMouse, DataTrak and DataTalk	
1.1	Personal programming of the dive computer (DataTalk)	58
1.2	Analysis and storage of real dives (DataTrak)	58
1.3	Updates (DataTrak, DataTalk)	58
VIII	Trouble Shooting	59
1	Trouble Shooting	60
IX	Appendix	61
1	Maintenance of Aladin® Sport Plus	62
2	Technical Information	63
3	Warranty	64
3.1	Recognition of warranty	64
3.2	Scope of the warranty	64
3.3	Warranty period and claim	64
4	Safety considerations	65
5	Serial No. / Dealer address	66

I Introduction

1	Aladin® Sport Plus - Safe No-Stop Diving	10
2	Aladin® Sport Plus – Your Personal Companion	10
3	The Calculation Model ZH-L8 ADT	3.1 Description 12 3.2 Advantages 13
4	Safety in Diving	14

1 Aladin® Sport Plus - Safe No-Stop Diving / 2 Your Personal Companion

1 Aladin® Sport - Safe No-Stop Diving

The proven no-stop dive computer Aladin is furnished with a new, revolutionary calculation model which makes it even safer and more comfortable. The Aladin® Sport Plus is designed for no-stop diving, but also provides the necessary information for safe diving in case of a decompression dive. Aladin® Sport Plus displays all information necessary for safe diving in such a manner that it is easy to survey and to be understood at once.

The convincingly simple handling and the high comfort of carrying speak for themselves from the first dive.

Read this operating manual carefully and to the last page.

2 Aladin® Sport Plus Your Personal Companion

Aladin® Sport Plus considers your individual reactions during the dive and the cooling of your skin. The latest results of medical and technical research were taken into consideration. As a special feature the calculation model also considers the formation of micro-bubbles and the skin temperature. This has led to the development of a unique, adaptive calculation model.

Aladin® Sport Plus was exclusively designed for diving with compressed air and especially for diving in the no-stop range. It distinguishes itself from its previous models and other commercial diving computers in a number of significant ways.

- The ZH-L8 ADT decompression calculation model considers eight body tissues as well as the diver's conduct and the ambient conditions. This allows for an even more precise calculation of a modeled risk for decompression sickness which can lead to greater diving safety.
- Compared to all previous models the Aladin® Sport Plus is much more of a personal instrument, which considers the individual conduct of the diver.
Different conducts of diving buddies can lead to distinctive differences in the display of the no-stop and decompression information, since risk situations (violations of the diving rules) may have a strong influence by the anticipation of physiological processes. On the other hand, Aladin® Sport Plus "rewards" a diving conduct following the rules with highest diving comfort.
- The new calculation model considers for the calculation of the surface intervals and the decompression

1 Aladin® Sport Plus - Your Personal Companion

information for repetitive dives that the physical performance at the surface is smaller than during the dive.

- The Aladin® Sport Plus uses optical alarms in risk situations or dangerous conduct.



You must strictly observe all optical alarms due to risk situations or dangerous conduct and take appropriate action based upon those alarms to avoid serious injury or death from decompression sickness!

- By using the Aladin® Sport Plus's logbook, a diver may directly call up information from the last 19 dives. When interfaced with a personal computer, 37 dives and 200 minutes of dive profile in intervals of 20 seconds can be read out.
- The dive planner allows the advance planning of no stop dives with readily determinable surface intervals.
- Aladin® Sport Plus is designed to be carried on the diver's wrist. Ease handling, easy to watch and unambiguous arrangement of the data in the display, increase of diving safety without the loss of diving comfort and the possibility of transferring data to a personal computer are the main features of the Aladin® Sport Plus comfort.

3 The Calculation Model ZH-L8 ADT

3.1 Description

The Aladin® Sport Plus uses a new decompression calculation model known as the ZH-L8 ADT. This model uses eight compartments or “tissue” groups with nominal half time periods from 5 to 640 minutes. This model differs considerably from other models by its consideration of the following additional physiological processes:

1. Blood perfusion to the body’s organs is not constant. Skin and muscle tissues are especially subject to changes in blood perfusion, depending on temperature and work load. Changes in blood perfusion to these organs change their nitrogen saturation tolerance. The model used by the Aladin® Sport Plus takes these effects into account and thus the “skin” and “muscle” compartments in the Aladin® Sport Plus show variable half-time periods and saturation tolerances. Decompression information is calculated according to the workload and decrease in skin temperature. The decrease in skin temperature is based upon the water temperature and the dive time. By considering these changes in saturation, the time that must be spent at the surface prior to flying can be considerably lengthened, depending upon the depth, time, and temperature of a dive, as well as the diver’s work during that dive.
 2. The decompression model used by the Aladin® Sport Plus considers nitrogen in both its dissolved as well as its gaseous phase (microbubbles). Formation of microbubbles is considered to be a strong indicator of a high risk of decompression sickness. The Aladin® Sport Plus model calculates the formation of microbubbles depending on various assumed influences in arterial and venous blood. In normal, slow ascents, microbubbles form mainly in venous blood. During fast ascents, microbubbles may also form in arterial blood and in the body’s tissues as well. If a particular dive profile may result in the creation of microbubbles according to the Aladin® Sport Plus’s model, decreased bottom time and/or increased decompression times as well as increased “no fly” time will be indicated.
- Microbubbles can form if the diver makes too fast an ascent, ignores required decompression stops, or makes repeated ascents during a dive (yo-yo diving). These microbubbles can form in arterial blood as well as in the body’s tissues. If these microbubbles partially impair circulation, the rate of gas diffusion and saturation tolerance for those tissues immediately surrounding this area of impaired circulation are changed. If required, no-stop time, decompression time and -depth will be adjusted in such a way that already existing microbubbles will stop growing. Increased decompression time will also assist those local areas of impaired circulation to desaturate with less risk of decompression sickness.

- The calculation of microbubbles results in altered ascent instructions. If microbubbles are assumed to be present based on the data used by the Aladin® Sport Plus, the ascent rate to the surface is reduced to 23 feet/minute. This will help prevent the formation of microbubbles in the arterial circulation and minimizes formation of microbubbles in the venous circulation after the dive.

3.2 Advantages

On first dives with correct diving technique and avoiding risk situations, there are no extended decompression times. On the other hand, it is possible to react correctly in risk situations due to the realistic simulation of the physiological processes in the body. This increases safety considerably. Risk situations are, for example:

- Repetitive dives, especially those deeper than 20 metres and those with short surface intervals.
- Repetitive diving over the course of several successive days.
- Diving in cold water.
- Yo-yo diving (repeated descents and ascents to the surface during a given dive).
- Flying within 24 hours after diving.
- Excessive ascent rate.

In case of mistakes on the part of the diver, actual prevention of decompression sickness is possible for the first time due to the reconstruction of the bubble formation and its consequences. The correction of the decompression must not be confused with a real recompression, which serves as therapy of already existing damage.

4 Safety in Diving

If signs or symptoms of decompression sickness occur after diving with Aladin® Sport Plus, seek IMMEDIATE treatment at the nearest recompression facility.

With its new decompression model Aladin® Sport Plus offers a so far unreached level of safety. However, responsibility for the dive finally remains with the diver as before. The usual diving caution is still absolutely necessary when diving with Aladin® Sport Plus.

In case of diver mistakes (ignoring decompression stops, excessive ascent rate etc.) Aladin® Sport Plus can calculate a corrected ascent instruction immediately which minimizes the occurrence of decompression sickness. The prevention of barotrauma and nitrogen narcosis still lies in the hands of the diver.

Aladin® Sport Plus is a highly developed technical instrument of high reliability. Despite this, the user of the Aladin® Sport Plus is to have an understanding of the physiological interrelations, to know the use of decompression tables and to have them with him on every dive.

Should an incident occur, the detailed previous history of the incident is stored in the dive computer. The evaluation of these records allows better diagnosis and the most effective treatment for the diver.

II Aladin® Sport Plus – Survey



1	Aladin® Sport Plus System	16
2	Operation	17
2.1	Operating for surface functions	17
	Switching on display	17
	Switching off display	17
	Active backlight	18
2.2	Operating modes	22

1 The Aladin® Sport Plus-System

1



The dive computer as the central unit of the Aladin® Sport Plus system becomes a valuable aid by a number of additional features:

- 1 During the dive the Aladin® Sport Plus dive computer supplies all important dive- and decompression information and warnings if necessary. It has a logbook with the last 19 dives and a dive planner.
- 2 The dive computer has a data memory which stores the dive data. The data can be downloaded out into a MemoMouse from where they can be transmitted to a Windows® personal computer with the logbook program DataTrak. MemoMouse and DataTrak are available as an option.

depth	dive time
18.7	57:
28.4	NO STOP 30:
max. depth	deco info

2

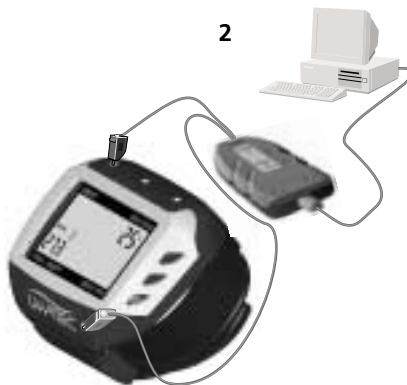

2 Operation

2.1 Operating the surface functions

Switching on display: – automatically, on submerging in water or when adaptation to atmospheric pressure is necessary.

– manually by manipulating contacts on housing.

Switching off display: – automatically, after three minutes without operation.

Aladin® Sport Plus has 4 operating contacts B, E, +, – on the outside of the housing. For manual operation, touch base contact B and any one of the other three contacts above the display with moistened fingers.

Contact B:

Base contact, which has to be touched for all operations.

Contact E:

Enter contact. It serves the switching on of the computer and the activation of logbook and diveplan-mode. It is also used to confirm inputs and is therefore comparable to the ENTER- or RETURN-key of a computer.

+ / – contacts:

They serve the selection of logbook and dive-plan as well as the setting of values (time, depth, dive-number etc.).



2 Operation

Active backlight

The display of the Aladin® Sport Plus can be illuminated both on the surface and underwater.

The backlight can be switched on by pressing the unit above the display.

The light will turn off automatically after 7 seconds.

The backlight can only be activated if the computer display is on.



- The active backlight is no substitute for a dive torch. When diving at night or at increased depth we recommend the use of a dive torch.
- Replace the battery if the battery warning appears. See page 38.



2 Operation



On page 2 of the English manual you will find a reference guide.
On page 3 of the German manual you will find an openable operating scheme.

1

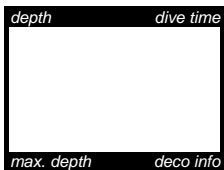

2

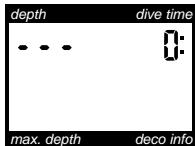

Ready-Modus

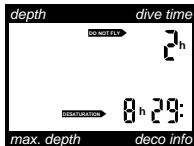

Surface-Modus

3

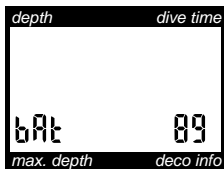

1. Aladin® Sport Plus is in a state of rest; no information is displayed (-> sleep-mode or -> surface-sleep-mode).
2. Bridging B and E activates the display -> ready-mode or -> surface-mode.
3. A second bridging of contacts B and E activates the display of the remaining battery capacity for approximately 5 seconds.
As soon as the battery capacity is 0%, a battery alarm is sent (see page 30).
There is still a small reserve left at bAt 0%.

2 Operation

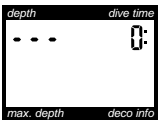

Ready-Modus

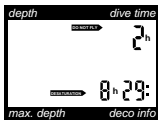

Surface-Modus



4

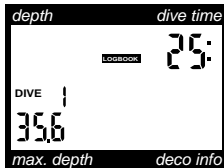
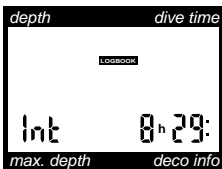

4.a Selecting the logbook function:

B and +

Back: B and -

or automatically after three minutes without operation

4.b Activating the logbook:

B and E. Aladin® Sport Plus shows the most recent dive.

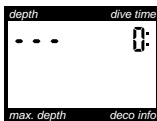
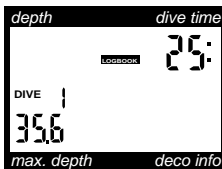

Ready-Modus

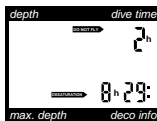

Surface-Modus

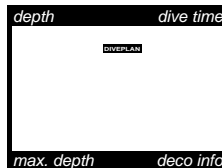
or after
3 minutes**4.c Leaving the logbook:**

B and E
or automatically after three minutes without operation.

5.a Selecting the dive-plan function:

B and -.
Back: B and +:
or automatically after three minutes without operation.

2 Operation

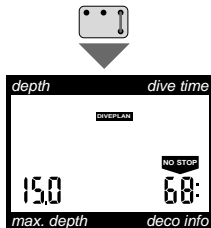

or after 3 minutes

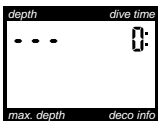

Ready-Modus

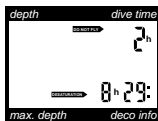

Surface-Modus

2.2 Operating modes

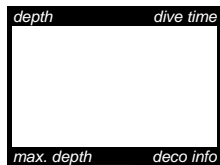

Aladin® Sport Plus works in various operating modes:

Sleep-mode:

Activation: automatically

When Aladin® Sport Plus is not used, it is in the so called sleep-mode.

In that case, the electronics are “sleeping” in that the display does not show any information. The computer is briefly activated once every minute to measure atmospheric pressure. The display remains switched off. If a change in altitude is recognized, Aladin® Sport Plus switches to -> surface-mode for 3 minutes.

5.b Activating the dive-plan

B and E. Aladin® Sport Plus starts by listing no-stop times. If the dive-plan is activated out of the surface-mode, enter the desired interval by B and + or B and -. Confirmation with B and E.

5.c Leaving the dive-plan:

B and E for approx. 3 seconds:
or automatically after three minutes.

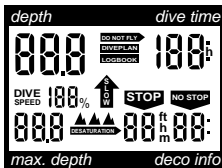
**Ready-mode:**

Activation: By touching contacts B and E from sleep-mode.
To check the display, all signs light up for 5 seconds.

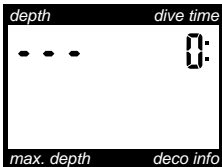

Aladin® Sport Plus switches into ready-mode afterwards. Once in ready-mode, the display is switched on and altitude sections are eventually displayed. By touching contacts B and E in the ready-mode once more, Aladin® Sport Plus will display the remaining battery capacity by percentage. Three minutes after activating the ready-mode, Aladin® Sport Plus will fall back into the —> sleep-mode.

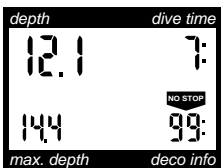
**Dive-mode:**

Activation: automatically, when depth more than 0.5 m.
In dive-mode all diving functions are monitored: i.e. depth and dive time are displayed, maximum depth is stored, saturation of tissues is calculated with allowance for temperature, no-stop time or decompression prognosis is determined, ascent rate is controlled and displayed and the correctness of the decompression procedure is supervised.

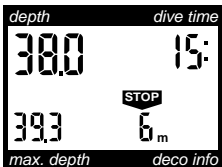

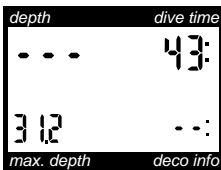

Wait-mode:

Activation: automatically on reaching the surface.

The wait-mode is activated if the the diver surfaces (diving depth less than 0.5 m). At the surface, the dive is not completed and entered into the logbook for an interval of 5 minutes. This allows a short surfacing for the purpose of orientation.

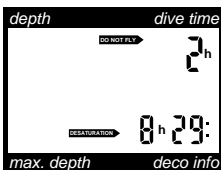

Surface-mode:

Activation: automatically after a dive or when changing altitude.

After a dive has been completed, Aladin® Sport Plus is in surface-mode. All data belonging to the surface interval are calculated and displayed: simulation of microbubble formation, actualization of the saturation of tissues depending on the calculated skin temperature and the assumed work load at the surface, calculation of desaturation time and no fly interval.

In order to save energy, Aladin® Sport Plus falls into the “surface-sleep” after 3 minutes. The functions of surface-mode are then carried out in the background. The atmospheric pressure is measured in surface-sleep once every minute. If the atmospheric pressure decreases, for example in case of change of altitude, Aladin® Sport Plus switches from sleep-mode or from surface-sleep into surface-mode automatically and displays the adaptation time. The adaptation time is the time after which all body tissues have adapted to the ambient pressure (= desaturation time).

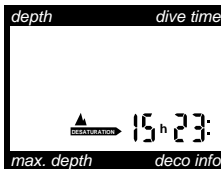

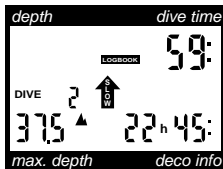
**Logbook-mode:**

Activation: manually by contacts

Data of 19 past dives can be called up in the logbook-mode. It shows maximum depth, dive time, preceding interval*, altitude sections and, where appropriate, alarms. A dive is entered in the logbook if it has lasted more than 2 minutes. When the dive was a repetitive dive then it also shows the interval which has passed since the last dive or a preceding change of altitude. The last 37 dives and the last 200 minutes of dive-profiles can be downloaded out into a MemoMouse and later from there into a personal computer (Windows®).

- * Preceding interval is only shown when the computer calculated that there was a residual nitrogen uptake at the beginning of the logged dive.

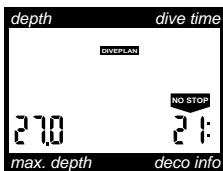
**Diveplan-mode:** Activation: manually by contacts

The diveplan-mode serves the planning of a future dive. It allows the planning of no-stop dives at various depths. On repetitive dives, the surface interval can be chosen at will. Calculations are based on the temperature data of the last dive and assuming normal workload.

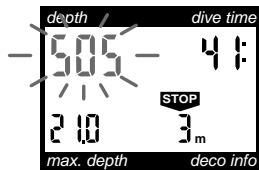

SOS-mode:

Activation: automatically

If the diver remains above a depth of 0.5 metres for more than three minutes without observing the prescribed decompression, the computer switches into SOS-mode after the dive and displays <SOS> instead of the depth. The computer is locked from use for the next 24 hours. Desaturation is further calculated including microbubbles in the tissues. Diving is again possible after 24 hours, but the SOS-mode can influence the calculations of Aladin® Sport Plus for three days after the incident due to the possible presence of microbubbles.



If a diver using Aladin® Sport Plus experiences a diving accident resulting in decompression sickness, the dive can be analyzed by means of the MemoMouse and DataTrak-software.

An automatic program transmits the logbook data – after connecting the dive computer via MemoMouse with a PC – once a minute from the locked dive computer to the personal computer. Dive computer, MemoMouse and PC need to be connected. The PC has to be ready for receiving data and the DataTrak „download-procedure“ has to be activated.



Serious injury or death may result if a diver does not seek immediate treatment at a recompression chamber should any signs or symptoms of decompression sickness occur after a dive.

III Diving with Aladin® Sport Plus

1	Terminology/Symbols	28
2	Attention Messages and Alarms	29
	2.1 Attention messages	29
	2.2 Alarms	30
	2.3 Alarm low battery	30
3	Preparation for the Dive	31
4	Functions during the Dive	32
	4.1 Dive time	32
	4.2 Current depth	32
	4.3 Maximum depth	32
	4.4 Ascent rate	33
	4.5 Decompression information	34
5	Functions at the Surface	35
	5.1 End of a dive	35
	5.2 Desaturation time	36
	5.3 No fly time	36
	5.4 Warning of bubbles	37
6	Diving in Mountain Lakes	37

1 Terminology/Symbols

The Aladin® Sport Plus is a dive computer primarily designed for diving in the no-stop phase. If a decompression dive is carried out in spite of that, the Aladin® Sport Plus offers a decompression prescription. The indications of the display vary depending on the phase of the dive.

No-stop phase: Dive phase during which ascent is allowed without decompression stops.



Decompression diving should not be attempted by recreational or sport scuba divers. Do not use the Aladin® Sport Plus for intentional decompression diving.

Decompression phase: Dive phase during which a decompression stop has to be observed during the ascent.

Decompression depth: Lowest stage is displayed.

Dive time: Time of the dive below depth of 1.2 m.

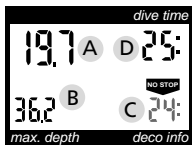

Display during no-stop phase

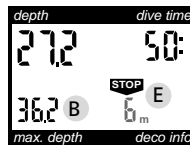
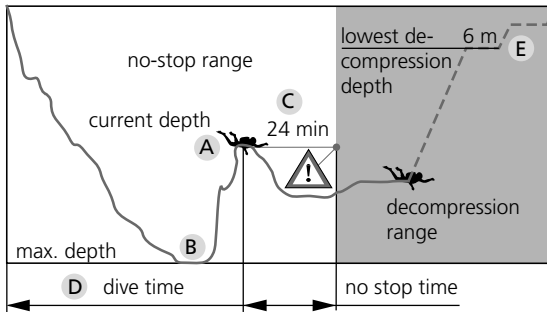

Display during decompression phase

2 Attention Messages and Alarms



Aladin® Sport Plus draws the diver's attention to certain situations and warns the diver of unsafe diving practices. Attention messages and alarms are communicated to the diver optically by lit up symbols, letters or flashing figures.

2.1 Attention messages

Attention messages come up in the following situations:

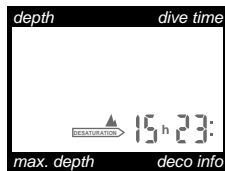

Dive in mountain lake

On a change of altitude, the altitude section (0-3) and adaptation time is shown. See pages 37-38.

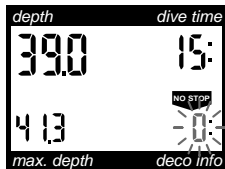

End of no-stop phase

In order to prevent a decompression dive ascend a few metres.

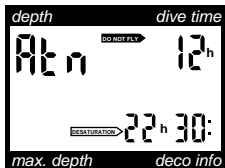

Warning of bubbles

Extension of the surface interval is recommended. See pages 37 and 54.

2 Attention Messages and Alarms

2.2 Alarms



Serious injury or death may result from failing to immediately respond to alarms given by Aladin® Sport Plus.

An alarm occurs in the following situations:

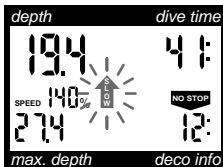

Excessive ascent rate.

Reduce ascent rate

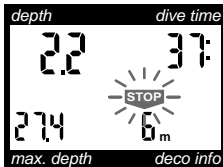

Ignoring decompression stop

Descend to the prescribed decompression depth at once!

2.3 Alarm low battery

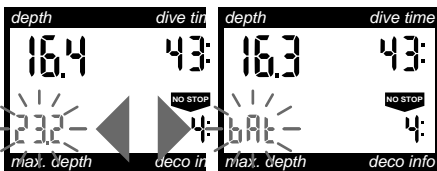

In dive-mode, <bAT> is indicated by a flashing display and alternating with the display of maximum depth as soon as battery capacity is 0%. In ready-mode and surface-mode, <bAT> is shown instead of maximum depth. Have the batteries changed by your retailer!

3 Preparation for the Dive



Basically, Aladin® Sport Plus need not be switched on manually. When submerged in water, the contacts are bridged by the water and the dive computer switches into dive-mode directly.

It is advisable to check the functions immediately before the dive in the diving location:

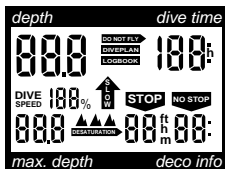

1. Switching on Aladin® Sport Plus manually

Bridge contacts B and E with moistened fingers. Check test display: Are all displays lit?

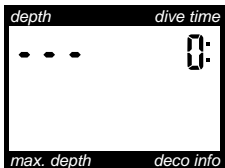

2. The Aladin® Sport Plus is now in ready-mode

After three minutes without operation or submerging in water, Aladin® Sport Plus switches off the display. It need not be switched on again. It switches on automatically on submerging in water and activates the dive-mode as soon as a depth of more than 0.5 m is reached. The display of the depth will appear a little delayed.



In extremely pure freshwater, it is possible that the Aladin® Sport Plus does not activate into dive-mode immediately. But Aladin® Sport Plus reacts to the leap of pressure on descending and switches on with a delay of up to a minute into → Dive-mode. There is no need of switching on manually.

4 Functions during the Dive

4.1 Dive time

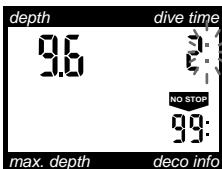

The whole time spent below a depth of 1.2 metres is displayed as dive time in minutes. While the dive time is running, the colon on the right of the figures is flashing in one second intervals. Maximum dive time displayed is 199 minutes.



If a dive lasts longer than 199 minutes, dive time is continued at 0 minutes.

4.2 Current depth

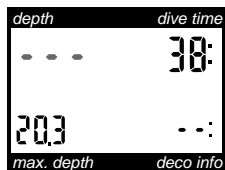
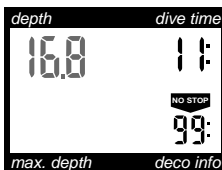

Current depth is given in 10 cm increments. On switching on and at a diving depth of less than 0.5 m the void display <—> appears.

Depth measurement is based on freshwater. Therefore, Aladin® Sport Plus shows a slightly greater depth than actually true when diving in salt water, depending on the salinity of the water.

4.3 Maximum depth

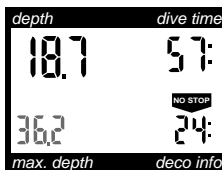



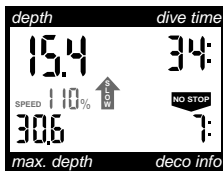

Maximum depth is displayed if it is lower than the current depth (maximum indicator function). To prevent the display changing very frequently when diving in the vicinity of maximum depth, it is only displayed if it exceeds the current depth by more than one metre.

4.4 Ascent rate

Optimal ascent rate varies between 7 and 20 m/min dependent on the depth. It is displayed in percent of the set value. If the ascent rate is bigger than 100% of the set value, the black arrow <SLOW> appears. If the ascent rate exceeds 140%, the arrow starts flashing.



	Ascent rate	Optical alarm
	SPEED 110%	
	SPEED 140%	



The prescribed ascent rate must be observed at all times! Exceeding the prescribed ascent rate can lead to microbubbles in the arterial circulation which can lead to serious injury or death due to decompression sickness.

Excessive ascent rates of longer periods are entered in the logbook.
Response: Reduce ascent rate.



- It is possible that Aladin® Sport Plus demands a decompression stop within the no-stop phase because of the danger of the formation of microbubbles.
- Decompression time necessary for the prevention of microbubbles can increase massively, if the ascent rate is exceeded.
- From great depth, too slow an ascent causes super-saturation of tissues and an extension of decompression time and total ascent time. From little depth, shortening of decompression times is possible because the tissues already start desaturating during the ascent.

4 Functions during the Dive

4.5 Decompression information

No-stop time is displayed if no decompression stops are necessary. The arrow <NO STOP> is visible if no decompression stops are necessary. The figures indicate no-stop time in minutes.

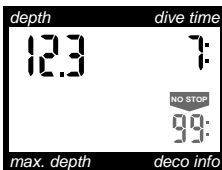

- No-stop display <99:> means remaining time of 99 minutes or more.
- No-stop time is calculated on assuming normal workload and current water temperature.

Message: In the last minute of the no-stop phase, the no-stop display shows the flashing value <0>.



Response: In order to prevent a decompression dive, you have to ascend a few metres after this message.

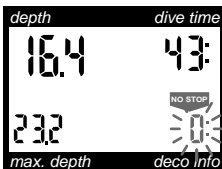

Decompression values

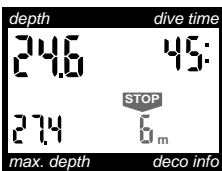

On entering the decompression phase, the arrow <NO STOP> extinguishes. The arrow <STOP> appears. Right below the arrow, the lowest decompression stage in metres is displayed. The display <6m> means that a decompression stop at a depth of 6 m has to be made.

When a decompression stop has been finished, the next higher is displayed. When all decompression stops have been made, the arrow <STOP> extinguishes and the arrow <NO STOP> reappears. The indication of time on the lower right shows the no-stop time again.

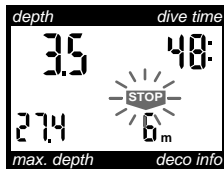

Messages: The decompression alarm is activated if the decompression stop is ignored. Arrow <STOP> flashes. Due to the formation of microbubbles decompression can increase massively while a decompression stop is ignored. If the surface is reached during the decompression alarm, the arrow <STOP> continues flashing, in order to point to the risk of a decompression accident. The SOS-mode is activated 3 minutes after the dive. If the total (cumulative) duration of the decompression alarm is longer than a minute it is entered in the logbook.

Response: Descend to the prescribed decompression depth immediately!

5 Functions at the surface

5.1 End of a dive

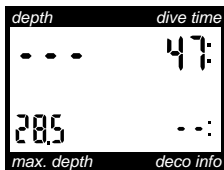

After reaching the surface, Aladin® Sport Plus switches into wait-mode automatically for five minutes. This is the time span necessary to recognize the end of the dive.

The delay allows the diver to come to the surface for orientation and to resume the dive afterwards.

When the dive is closed after 5 minutes in wait-mode, it is entered into the logbook and Aladin® Sport Plus switches into surface-mode.

In surface-mode, Aladin® Sport Plus shows desaturation time and no fly time.

5 Functions at the surface

5.2 Desaturation time

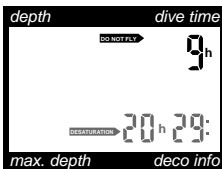

Aladin® Sport Plus is in surface-mode. The arrow <DESATURATION> appears; beside desaturation time in hours and minutes is displayed. Desaturation time is continually indicated until the next dive or until it reaches zero. The display is switched off to save energy 3 minutes after the last manipulation (surface-sleep-mode). Desaturation calculations continue to be made in the background.



- In some cases, desaturation times with the Aladin® Sport Plus are considerably longer than those of other models. This is because the calculation model assumes reduced physical activity at the surface (therefore less nitrogen off gassing) and uses shorter half-times.
- If desaturation time reaches zero, the "tissue" models of the Aladin® Sport Plus are desaturated and it switches into the sleep-mode

5.3 No fly time

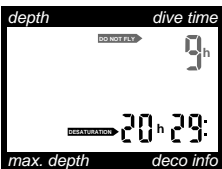

The waiting period until the next flight is indicated as follows: <DO NOT FLY>; beside, time in hours.

In some cases the no fly time is considerably longer than with other models (reason: see desaturation time).



The no fly time must be strictly observed because of the danger of the formation of gas bubbles.

5.4 Warning of bubbles

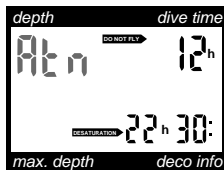

Through repetitive dives microbubbles may accumulate in the lungs if the surface interval is not long enough. Ignoring decompression stops or an excessive ascent rate can also lead to bubbles in tissues. In order to reduce the risk of decompression sickness for future repetitive dives, the surface interval should be planned long enough to reduce the risk of decompression sickness. If Aladin® Sport Plus calculates that the formation of microbubbles may occur during the surface interval, it will advise a diver to extend the surface interval. If the display <Atn> (=attention) is visible instead of the depth during the surface interval (surface-mode), the diver has to extend the surface interval. Through the extension of the interval the diver may prevent a high concentration of bubbles in the lungs during the planned dive and avoids a situation of higher risk.



- If the dive has to be made during <Atn>-time, the <Atn> time of the following dive can increase considerably.
- If the dive is made in spite of the display <Atn>, the diver must cope with a clearly shorter no-stop time and an extension of decompression.

6 Diving in Mountain Lakes

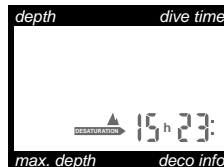

Aladin® Sport Plus also measures the atmospheric pressure in sleep-mode. If the computer detects a higher altitude section, it switches into surface-mode automatically. Desaturation time indicated at this moment refers to adaptation time at this altitude. If diving starts within this adaptation time, Aladin® Sport Plus treats it as a repetitive dive, since the body still has a higher saturation.

The entire altitude range is divided into four sections which are influenced by meteorological circumstances. That is why the following altitude sections overlap on their fringes. The altitude section is indicated at the surface, in the logbook and in the dive planner by stylized mountains, if a mountain lake altitude is reached. Section 0 is not indicated. In the following, you can see the approximate altitude ranges of the four sections:

6 Diving in Mountain Lakes

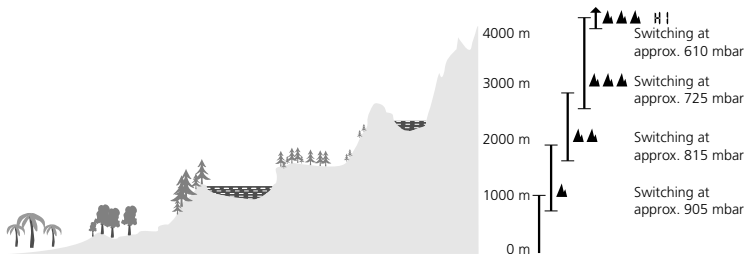

In order to assure optimal decompression also at higher altitudes, the 3 m decompression stage is divided into a 4 m stage and a 2 m stage (the prescribed decompression depths are in consequence 2 m, 4 m, 6 m, 9 m...).

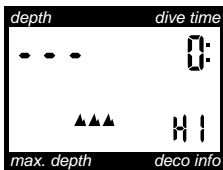

Aladin® Sport Plus can be used as dive computer in case of an emergency up to an altitude of 4000 m. If atmospheric pressure is below 620 mbar (higher altitude than 4000 m above sea level), no decompression information is displayed any more. Dive-plan-mode can no longer be started, since no decompression information is available. Beside the display of the altitude section 3, <HI> (=high) appears to tell the diver that he will not get any decompression information for the dive. Very small differences in the pressure sensors can cause an indication of different altitude sections of two dive computers at the same altitude on the fringes of the altitude ranges. These differences are not meaningful and do not interfere with the safety of Aladin® Sport Plus. But if an altitude section is displayed at sea level or the altitude informations of two computers differ by more than one altitude section (e.g. section 2 instead of 0), there may be a defect of the computer. In this case, send your computer back to your retailer for checking.



Diving while at altitude can considerably increase the risk of decompression sickness. Do not undertake high altitude diving without being specifically trained in the special techniques of such diving.

IV Diving at Reduced Risk with Aladin® Sport Plus

IV

1 Diving at Reduced Risk with Aladin® Sport Plus

1.1	Diving at reduced risk _____	40
1.2	Diving at reduced risk for the first dive _____	40
1.3	Minimizing risk on repetitive dives _____	41
1.4	Response in increased risk situations _____	42

1 Diving at Reduced Risk with Aladin® Sport Plus

1.1 Diving at reduced risk

Aladin® Sport Plus recognizes and reacts “intelligently” to certain risk situations, although of course it is much better that each individual diver avoid these higher risk situations altogether. If a decompression accident does occur, the optional MemoMouse and DataTrak software allows the analysis of the dive profile and certain risk parameters to provide for more complete information for treatment purposes.

Analysis of the most recent results of decompression research and statistical analysis of diving accidents involving decompression sickness supports the following guidelines for diving with a reduced risk of decompression sickness.

The following suggestions are highly recommended:

1.2 Diving at reduced risk for the first dive



Neither the Aladin® Sport Plus nor any other diving computer or decompression table can guarantee that decompression sickness will not occur even if the computer or table is used correctly and all of the following precautions are followed.

- Always make the deepest dive of the day first when repetitive dives are planned, and for each dive make sure that the deepest portion of that dive is done at the beginning of the dive.
- Avoid repeated ascents and descents (yo-yo diving).
- Avoid repeated heavy workload whilst at depth.
- Plan the dives shorter if they are made in cold water.
- After finishing the decompression or at the end of a no-stop dive, the final stage of the ascent should be as slow as possible.
- On all dives with the Aladin® Sport Plus, make a safety stop for at least three to five minutes within the 3 to 5 metre zone.
- In accordance with the recommended maximum diving limit, do not dive deeper than 40 metres.
- Comply with the ascent rate and carry out any decompression stop required.
- If the Aladin® Sport Plus fails at any time during the dive, the dive must be terminated, and appropriate surfacing procedures should be initiated immediately.
- You **MUST** follow the ascent rates as indicated by the Aladin® Sport Plus and if the computer should fail

1 Diving at Reduced Risk with Aladin® Sport Plus

for any reason, you must ascend at a rate of no greater than 10 metres per minute.

- All divers using dive computers to plan dives and indicate or determine decompression status must use their own diving computer.
- On any given dive, both divers in a buddy pair must follow the most conservative dive computer for that particular dive.
- You **MUST** be familiar with all signs and symptoms of decompression sickness before using the Aladin® Sport Plus! Seek **IMMEDIATE** treatment for decompression sickness should any of these signs or symptoms occur after a dive! There is a direct correlation between the effectiveness of treatment and the delay between the onset of symptoms and the treatment for decompression sickness.
- Always observe the optical alarm signals of the Aladin® Sport Plus. Avoid situations of increased risk which are marked with a warning sign in this operating manual.
- Never dive the Aladin® Sport Plus to the limits. Neither the Aladin® Sport Plus nor any other diving computer or decompression table should be pushed to its limit. Give yourself a margin of safety by always leaving at least a few minutes in the “no-stop” box before making your ascent.
- Do not use the Aladin® Sport Plus for planned decompression diving. The decompression algorithm contained in the Aladin® Sport Plus should be used only for emergency or unintended decompression.
- The Aladin® Sport Plus is designed for dives made with compressed air only. Do not use the Aladin® Sport Plus for dives made with nitrox or other mixed gases.
- Make sure you always have enough air for the ascent.

1.3 Minimizing risk on repetitive dives

With consecutive repetitive dives, there will be excess nitrogen in the body due to the accumulation of nitrogen on the preceding dives. Depending on the length of the surface interval, there could even be gaseous nitrogen (microbubbles) in your body. This accumulation of both absorbed as well as gaseous nitrogen in the body can greatly increase the risk of decompression sickness on subsequent dives. That risk can be minimized.

- Respect the rules for the first dives.
- Always make your first dive the deepest dive of the day.
- Always make the deepest descent of each given dive on a particular day at the beginning of that dive.
- Repetitive dives after exchanging the dive computer: Wait at least 24 hour before you start with the repetitive dive.

1 Diving at Reduced Risk with Aladin® Sport Plus

- Plan for a minimum surface interval of three to four hours.
- Do not attempt to repetitive dive if the <Atn> is visible on the display.
- Take a day off from diving every three or four days.

1.4 Response in increased risk situations

If the dive includes an increased risk situation, Aladin® Sport Plus reacts automatically to warn the diver of this risk. A change of decompression may be indicated to minimize the risk. The diver can further reduce the risk through his conservative diving practices on the next dive and at the same time prevent long decompression stops.

A few examples on the following pages:

Situation1:

Reaction of computer:

The diver ascends too rapidly:

The model calculates the formation of bubbles due to the excessively rapid ascent. No-stop time is shortened or a decompression prescription is displayed in order to assure increased decompression.

Recommended response of the diver

During the dive:

- Observe the decompression prescription shown by Aladin® Sport Plus

After the dive:

- Watch out for symptoms of arterial gas embolism and decompression sickness.
- Seek immediate medical attention at a recompression chamber should any signs or symptoms of decompression sickness appear.
- Before the next dive, plan a sufficiently long interval (display <Atn> should disappear).



- An excessive ascent rate can lead to serious injury or death from decompression sickness.
- Failure to seek IMMEDIATE treatment for any signs or symptoms of decompression sickness after a dive may result in serious injury or death.

Situation 2:

Reaction of computer:

The diver disregards the prescribed decompression depth.

The model calculates the formation of bubbles due to ignoring decompression. Waiting time at the displayed decompression stage is extended or a lower decompression stage is displayed in order to assure sufficient time for desaturation.

Recommended response of the diver

During the dive:

- Avoid decompression dives.
- Descend to the prescribed decompression depth at once.
- Do not descend to greater depths during the dive.
- Observe the decompression prescribed by Aladin® Sport Plus.

After the dive:

- Watch out for symptoms of arterial gas embolism and decompression sickness.
- Before the next dive, plan a sufficiently long interval (display <Atn> should disappear).



- Failure to comply with all decompression information on the Aladin® Sport Plus may result in serious injury or death due to decompression sickness.
- There is a risk of decompression sickness on every dive even if all precautions described in this manual are taken.

Situation 3: **The diver is physically exerting himself or herself, (e.g. swimming against the current).**

Recommended response of the diver

During the dive:

- Avoid further physical exertion if possible. Relax.
- Extend decompression time at the highest stop if possible.

After the dive:

- Refrain from heightened physical exertion on your next dive.
 - Make sure the surface interval is long enough. It may be advisable to go on another dive only the next day.
-

Situation 4: **It is very unlikely to have a surface interval long enough to clear the <Atn> prior to the next dive during an organized dive trip from a boat. This previous buildup of nitrogen must be taken into consideration for the next dive.**

Reaction of computer:

Aladin® Sport Plus calculates a shorter no-stop time or decompression prescription to reduce the risk of decompression sickness.

Recommended response of the diver

During the dive:

Dive conservatively on all repetitive dives. Limit your maximum depth to no more than 25 m at the very beginning of the dive and make a very slow ascent.

After the dive:

Before the next dive, plan a sufficiently long surface interval (<Atn> display should disappear).

V Logbook

V

1	Survey	46
2	Selection and Activation	47
3	Selection of Dive	48
4	Leaving the Logbook-Mode	49
5	Output on PC	50

1 Survey

The Aladin® Sport Plus records the last 37 dives and the dive profiles of the last 200 minutes of diving (see „Output on PC“ page 50). The last 19 dives can be displayed directly on the dive computer. A dive is only entered in the logbook if the dive time is longer than 2 minutes. Displayed information of the dive:

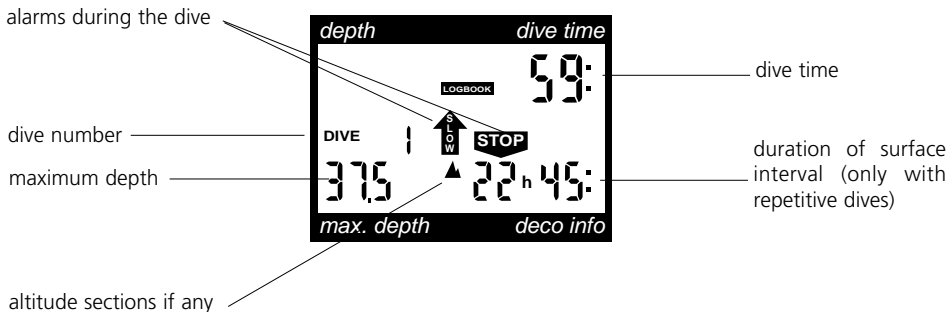

If a dive is started within adaptation time (after a change of altitude), the adaptation time is displayed instead of the surface interval.

2 Selection and Activation

V

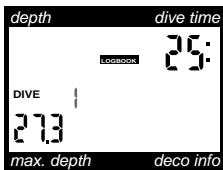
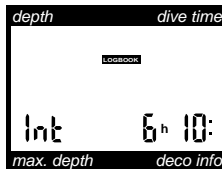
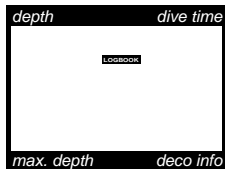
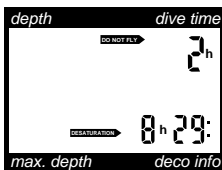
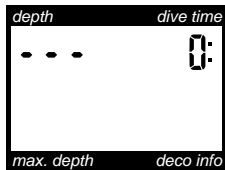

1. The logbook is selected by bridging contacts B and + in ready- or surface-mode. Indication <LOGBOOK> appears. If Aladin® Sport Plus has been in surface-mode before, the surface interval appears as well. You go back into ready- or surface-mode by B and -.

2. In order to activate the logbook, bridge contacts B and E. The most recent dive is displayed (DIVE 1).

3 Selection of Dive

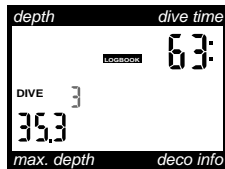
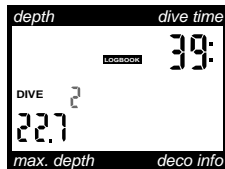
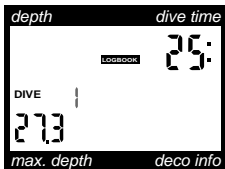

1. Bridge contacts B and + to get the information of the dive preceding the most recent one. Display <DIVE 2> appears.

2. On every further bridging B and + the logbook jumps to the next older dive (DIVE 3).

3. On constant bridging of the contacts all dives are displayed successively.

4. Bridging contacts B and – allows switching back from older dives to more recent ones.

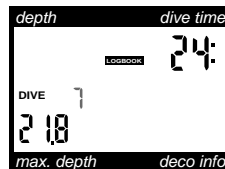
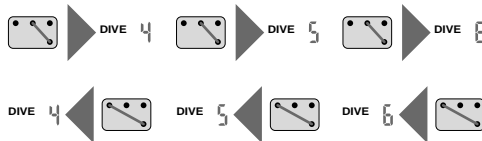

4 Leaving the Logbook-Mode

V

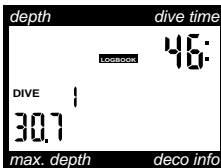

or after 3 minutes

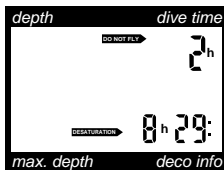
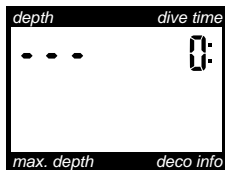

Touch contacts B and E.

Aladin® Sport Plus switches back into ready- or surface-mode. This also happens 3 minutes after activating logbook-mode.

5 Output on PC

The Aladin® Sport Plus stores data of the last 37 dives including a total of approximately 200 minutes of dive profiles from the last dives. This information can be downloaded into a Memo Mouse (optional), which stores up to approximately 66 dive hours. With the DataTark Windows® software (optional) the information can then be transferred from the MemoMouse to a PC.

Time and date of the dive are entered automatically, based on the clock of the PC-system when the data are transferred via interface.

The possibilities and the procedure of this data transfer are described in a separate manual.



1	Survey	52
2	Selection and Activation from Ready-Mode	52
3	Selection and Activation from Surface-Mode	53
4	Planning a No-Stop Dive	54
5	Leaving the Diveplan-Mode	56

1 Survey / 2 Selection and Activation from Ready-Mode

The Aladin® Sport Plus is equipped with a dive planner which allows the planning of no-stop dives with freely determinable surface interval. The water temperature of the most recent dive and eventual altitude sections are incorporated in the calculation.

The Aladin® Sport Plus does not allow the planning of decompression dives.

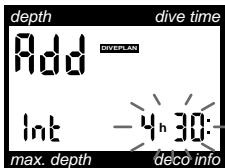

Presetting the surface interval (only during desaturation)

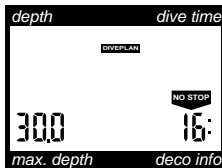

Planning of no-stop dives

2. Selection and Activation from Ready-Mode

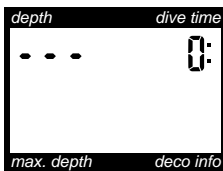

1. From ready-mode, you switch into the diveplan input stage with contacts B and -.

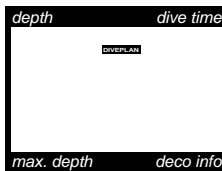

2. The display shows <DIVEPLAN>. You return to ready-mode by B and +.

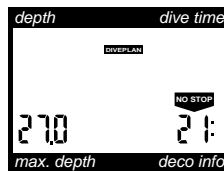

3. Contacts B and E afterwards activate the planning mode.

4. The display shows no-stop times for increasing depths (scrolling no-stop times).

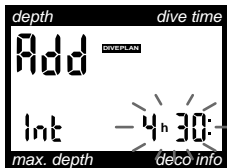
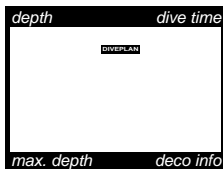
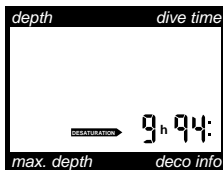

1. From surface-mode, you switch into the diveplan input stage by B and –.

2. The display shows <DIVEPLAN>.
You return to surface mode by B and +.

3. After confirming by B and E, the display shows <Add>, <Int> and the interval (flashing). Aladin® Sport Plus expects your input for the duration of the dive interval.

4 Planning a No-Stop Dive

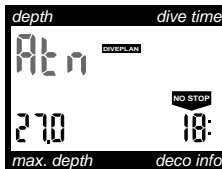
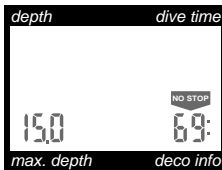
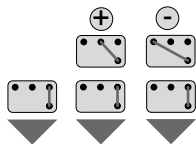
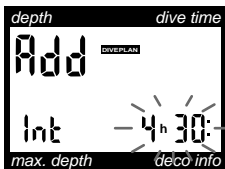

Aladin® Sport Plus expects your input for the duration of the dive interval.

- 4a If no surface interval is to be entered, (diving at the present moment), confirm this with contacts B and E, and you switch into no-stop planning.
- 4b You can extend the interval with contacts B and E. B and – shorten the interval.
- 5 You confirm the new surface interval and get into no-stop planning.

After confirming the surface interval (if possible), no-stop times are displayed in 3-metre-increments. The process starts with the plan depth of the no-stop time which must be shorter than 99 minutes. The no-stop time for every 3-metre-increments is displayed for about 3 seconds (scrolling no-stop times).

Repetitive dives usually cause more microbubbles in the lungs than first dives if the surface interval is not long enough. Too rapid an ascent and/or disregarding decompression instructions can lead to microbubbles. By calculating the formation of bubbles, Aladin® Sport Plus is able to advise the diver to extend the surface interval if necessary. If <Atn> is displayed instead of the depth in addition to the no-stop times, the diver should plan an extension of the interval if possible.

By repeated recalls of the diveplan with varying surface intervals the minimum interval can be determined.



- When diving in spite of the display <Atn>, a clear shortening of the no-stop time and/or an extension of decompression has to be expected.
- If a dive is made during <Atn>-time, the <Atn>-time following the dive can increase considerably.
- Making a repetitive dive when <Atn> is displayed will increase your risk of serious injury or death from decompression sickness!

5 Leaving the Diveplan-Mode

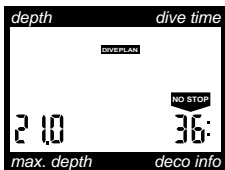

If the contacts B and E are touched, Aladin® Sport Plus falls back into ready- or surface-mode. This also occurs three minutes after the activation of the diveplan-mode.



or after 3 minutes

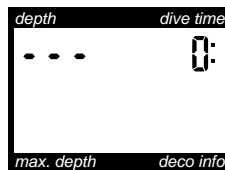

If two or more divers using computers are planning a dive, planning for all divers has to be based on the dive computer showing the shortest no-stop times. Failure to do this may lead to serious injury or death from decompression sickness.

1	MemoMouse, DataTrak and DataTalk	1.1	Personal programming of the dive computer (DataTalk) _____	58
		1.2	Analysis and storage of real dives (DataTrak) _____	58
		1.3	Updates (DataTrak, DataTalk) _____	58

1 MemoMouse, DataTrak and DataTalk

The Aladin® Sport Plus is able to communicate with a personal computer. The connection is established by contact sensors and the MemoMouse. The MemoMouse and the PC software DataTrak and DataTalk is available as an option. For the Aladin® Sport Plus it is only allowed to use DataTalk version 1.6 or higher. Communication with a personal computer (Windows®) has a number of advantages:

1.1 Personal programming of the dive computer (DataTalk)

By means of the Data-Talk-software you can choose, if depth is indicated in feet or metres.

1.2 Analysis and storage of real dives

The last approx. 200 minutes of dive time are stored by the dive computer in increments of 20 seconds and can be transferred to the PC. The DataTrak software allows the representation and analysis of the profiles. By this means all relevant data are examined and displayed for every point in time. The DataTrak releases 1.6 and higher recognize the Aladin® Sport Plus and display the respective data.

The PC program enables the diver to keep a personal logbook. Apart from the last 200 minutes of diving, 37 dives are recorded in the logbook of Aladin® Sport Plus. If the data from Aladin® Sport Plus are transferred regularly into the MemoMouse and then to the PC, all dives will be stored in the PC with their profiles. Time and date of the dives are automatically recorded and the dives can be printed out on a page for the diver's logbook.

1.3 Updates

The last versions of DataTrak and DataTalk are available for free from the Internet (<http://www.uwatec.com>). These programs are backwards compatible but not for MS-DOS.

VIII Trouble Shooting

symptom	possible reason(s)	response
Altitude section does not correspond to the current altitude.	Atmospheric pressure is especially high or low. Ambient air pressure measured by the computer is wrong.	Check barometric information. Send in dive computer for servicing (only if altitude section is wrong by more than one section, see page 37).
Desaturation time and /or no fly time are very long.	Too many repetitive dives, yo-yo-diving, square profile repetitive dives or disregarding decompression stops. Dissolved nitrogen and/or microbubbles must be off gassed first.	Plan sufficiently long surface interval and dives at lower risk.
<Atn> appears in place of the diving depth on the display.	Too many repetitive dives, too fast ascents, yo-yo-diving, square profile repetitive dives or disregarding decompression stops. Dissolved nitrogen and/or microbubbles must be off gassed first.	Plan sufficiently long surface interval and dives at lower risk. Review chapters III 5 and IV very carefully.
An unexpected decompression stop appears in place of no-stop time or decompression increases rapidly.	Too rapid an ascent or ignoring decompression stops have caused a large number of microbubbles, which leads to an attention message (warning of bubbles).	Plan sufficiently long surface interval and dives at lower risk. Review chapters III 5 and IV very carefully.

1	Maintenance of Aladin® Sport Plus	_____	62
2	Technical Information	_____	63
3	Warranty		
	3.1	Recognition of warranty _____	64
	3.2	Scope of the warranty _____	64
	3.3	Warranty period and claim _____	64
4	Safety considerations	_____	65
5	Serial No. / Dealer address	_____	66

1 Maintenance of Aladin® Sport Plus Dive Computer

Your The Aladin® Sport Plus is virtually maintenance free. All you need to do is to rinse it carefully with fresh water after each use and to have the batteries changed when needed. To avoid possible problems with your The Aladin® Sport Plus, the following recommendations will help assure that it will give you years of trouble free service:

- Avoid dropping or jarring your The Aladin® Sport Plus.
- Do not allow your The Aladin® Sport Plus to be exposed to direct, intense sunlight.
- Rinse your The Aladin® Sport Plus thoroughly with fresh water after each dive.
- Do not store your The Aladin® Sport Plus in an gas mixture-tight area; make sure there is free ventilation.
- If there are problems with operating the contacts, the surface of your The Aladin® Sport Plus housing can be treated with silicone grease. Use soapy water to clean the The Aladin® Sport Plus before using silicone grease and dry it thoroughly.
- There are borings in two of the contacts for the reception of the PC interface connection (MemoMouse). Free these borings from dirt with a needle if necessary.



Take the dive computer to an authorized Uwatec dealer in order to change the batteries. The actual change of the batteries is made at the manufacturer or the importer. The computer is checked for its technical functioning at the same time. Do not attempt to have the batteries changed by anyone other than an authorized dealer.

2 Technical Information

IX

Operating altitude: with decompression information: sea level up to approx. 4000 m
without decompression information: unlimited

Operating depth: no limitation in the permitted range of diving with compressed air



Do not dive deeper than 40 m.

Max. operating pressure: 13 bar

Clock: quartz timer, display up to 199 minutes

Operating temperature: -10°C to +50°C

Power supply: Special battery Uwaterc LR07

Life of the battery: (standard values)
For an average diving time of 60 minutes and a surface interval of 20 hours after every dive:

Number of dives per year	dive computer (years)
50	10
100	8
150	6
300	4

3 Warranty

Please pay attention to the following remarks on warranty claims:

3.1 Recognition of warranty:

The warranty only covers dive computers which have been provably bought from an authorized retailer or from the manufacturer.

3.2 Scope of the warranty:

The manufacturer will repair all defects which are provably retraceable to defects of material or faults in production. The warranty covers the repair of the dive computer free of charge, the replacement of faulty parts or the entire dive computer, respectively.

UWATEC reserves the right to determine the merits of a warranty claim and to determine whether the computer will be repaired or replaced.

Excluded are faults or defects due to:

- excessive wear and tear
- exterior influences, e.g. transport damage, damage due to bumping and hitting, influences of weather or other natural phenomena.
- Servicing, repairs or the opening of the dive computer by anybody not authorized by the manufacturer. This especially concerns the change of batteries of the dive computer.
- pressure tests which do not take place in water
- diving accidents

3.3 Warranty period and claim

The warranty is given for a period of 12 months. Repairs or replacements during the warranty period do not increase the warranty period.

In order to put forward a warranty claim, send the dive computer together with a dated receipt of the purchase to your authorized retailer or an authorized servicing point. The manufacturer does not have to accept extensions of the warranty granted by national importers.

4 Safety considerations

The Aladin® Sport Plus gives to the diver a high level of reassurance and safety. However these units can never be a substitute for a thorough diving education.

Pay careful attention to warnings given by the Aladin® Sport Plus. Do not make risky dives. Pay special attention to the parts of this manual which are marked with a warning sign.

Follow all standard safe diving practices:

- Never dive without a buddy. The Aladin® Sport Plus does not substitute for a dive buddy!
- Only make dives that are appropriate to your level of dive training. The Aladin® Sport Plus does not increase your knowledge of diving.
- Do not dive deeper than 40 m.

This manual is part of the Aladin® Sport Plus safety concept. Please confirm that you have read and understood the complete manual:

Place: _____ Date: _____ Signature: _____

5 Serial No. / Dealer address



**Serial No. of your
Aladin® Sport Plus**

Dealer address:

(Dealer to affix stamp)

Printed in Switzerland 1/00