





## WARNING

READ AND UNDERSTAND THIS MANUAL COMPLETELY BEFORE USING THE DC-12 DECOMPRESSION COMPUTER.

THIS IS A PRODUCT INFORMATION BOOKLET. THIS IS NOT A DIVING INSTRUCTION MANUAL, IT DOES NOT ELIMINATE THE NECESSITY FOR OBTAINING CERTIFIED DIVING INSTRUCTION, INCLUDING THE PRINCIPLES OF DECOMPRESSION. THE OWNER IS THEREFORE ADVISED TO OBTAIN SUCH INSTRUCTION, AS WELL AS A THOROUGH UNDERSTANDING OF THE INFORMATION IN THIS MANUAL, PRIOR TO DIVING WITH THE DC-12 DECOMPRESSION COMPUTER.

## TABLE OF CONTENTS

Section	Page
I Introduction .....	1
II Mounting .....	2
III Warnings .....	4
IV Dissolved Gas Theory .....	9
V Functions .....	10
VI Display .....	12
VII Computer Operation .....	14
Selecting Programs .....	14
Master Program Chart .....	15
1. Sleep Mode .....	16
2. Surface Mode .....	17
a. No-Deco Time Scroll .....	17
b. Time Before Flying .....	18
3. History Mode .....	18
a. Logbook .....	18
b. Max Depth Recorded .....	19
c. Total # Dives Recorded .....	20
d. Total Hours of Operation .....	21
e. Altitude On/Off .....	22
f. Dive Planner .....	23
4. Dive Mode .....	26
a. Activation .....	26
b. Elapsed Dive Time .....	27
c. Current Depth .....	27
d. Max Depth .....	27



4. Dive Mode (cont'd) .....	28
e. No Decompression Time .....	28
f. Decompression .....	28
g. DECO and ASC symbol .....	29
h. Graphic Triangle .....	30
i. Deco Stop Depth and Time .....	30
j. Command Arrows .....	30
k. Ceiling .....	32
l. Ascent Rate .....	33
m. Out of Range .....	34
n. Between Dives .....	36
o. Repetitive Dives .....	37
VIII Special Conditions .....	38
1. High Altitude Diving .....	38
2. Group Diving .....	39
3. Chamber Diving or Testing .....	40
4. Error Mode .....	40
IX Care and Maintenance .....	41
1. Battery .....	41
2. General .....	41
X Design Specifications .....	43
XI Glossary .....	44
XII Limited One Year Warranty .....	46

# I. INTRODUCTION

Congratulations on purchasing the DC-12 Decompression Computer. If used properly, the DC-12 will make your diving easier and safer. To gain the maximum benefits from the DC-12, and to use it properly and safely, you must read and thoroughly understand this Owner's Manual. The DC-12 Decompression Computer is a significant advancement in the development of diving computers. It has many remarkable features.

The heart of the DC-12 is a decompression model developed by Max H. Hahn, Ph.D., an internationally recognized authority in decompression theory and active diving instructor. Dr. Hahn's latest mathematical model is based not only on statistics of decompression sickness (dcs) symptoms but also on bubble measurements after wet chamber exposures of human subjects.

The DC-12 Decompression Computer has several pioneering features:

- ▶ A decompression model which:
  - keeps bubble grades low after 'first' dives
  - matches off-gassing speed to the expected bubble grades after the preceding dive.
  - allows two elevation ranges: From sea level to 2,300 ft (700 m) and for high altitude diving from 2,300 ft (700 m) to 8,200ft (2,500 m).
  - fights excessive dcs-risks of very deep dives as well as deeper-than-previous repetitive dives by adding appropriate decompression demands, if such profiles are not avoided.
- ▶ A unique, easy to read, intuitive display.
- ▶ A warning display on the DC-12 guides the diver to not exceed a safe ascent rate or ascend above his decompression ceiling.
- ▶ The DC-12 battery has a 10 year shelf life and has the capacity for approximately 8 years of active diving (at 70 dives per year).



- ▶ The DC-12 has a practical and convenient dive planner feature. You can simulate any dive profile in advance, considering any residual nitrogen retained in memory. The planner runs 12 times faster than real time so the dive can be simulated quickly.
- ▶ If submerged, the DC-12 is automatically switched on by water sensing contacts. You can manually switch on the instrument by bridging the contacts with wet fingertips.
- ▶ The DC-12 will display the air temperature on the surface.
- ▶ Vital information about no-stop decompression times and ascent rate are displayed in both digital and graphic format. This makes the computer easier to use and understand at a glance.

## II. MOUNTING

### CONSOLE

The DC-12 capsule can be mounted, by means of an adapter into the Scubapro V.I.P. 3-gauge console for hands free operation. See your Scubapro dealer for assistance.

### NOTE

If the DC-12 is fitted into any other manufacturers console, it must allow unobstructed water flow to the back of the DC-12 to sense water pressure.

### WRIST MOUNT

For wrist mounting, the DC-12 can be fitted to the Scubapro wrist strap. To install, the strap should be soaked in hot water for a few minutes to make it pliable, then insert the DC-12 into the strap from the bottom.

2

To tighten the strap, push against the strap lock with your thumb and pull the strap tight. Release the strap lock so it engages one of the slots in the strap. It may be necessary to retighten the strap at depth during the dive.

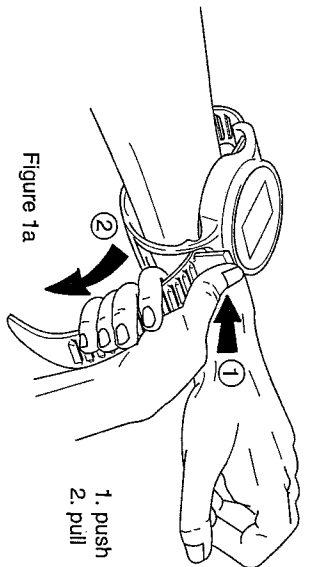

Figure 1a

To loosen, press the strap lock and pull out the strap enough to slide the strap over your hand.

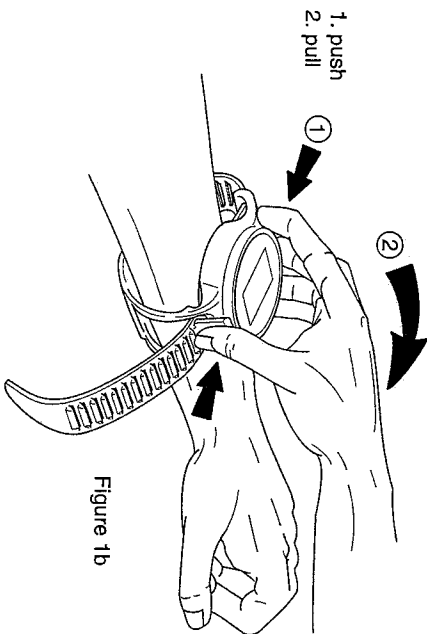

Figure 1b

3



### III. WARNINGS

**TO ENSURE SAFE DIVING AND PROPER USE OF THE DC-12 DECOMPRESSION COMPUTER, THERE ARE VERY IMPORTANT SAFETY WARNINGS WHICH MUST BE COMPLETELY UNDERSTOOD AND FOLLOWED:**

- 1. YOU MUST READ THIS ENTIRE MANUAL CAREFULLY.** Before you use the DC-12 Decompression Computer, you must be thoroughly familiar with the functions and operation of the Decompression Computer, and the risks associated with the use of the Decompression Computer. Therefore, before you dive with the DC-12 Decompression Computer, you must carefully read this entire manual. Pay close attention to all instructions — which include all warnings — contained in this manual. Make sure you closely follow all of the instructions when using the DC-12 Decompression Computer. Make sure you understand all of the instructions when using the DC-12 Decompression Computer. **IMPROPER USE OF THE DC-12 DECOMPRESSION COMPUTER CAN RESULT IN SERIOUS INJURY OR DEATH.**
- 2. THE DC-12 DECOMPRESSION COMPUTER DOES NOT AND CANNOT ELIMINATE THE RISK OF DECOMPRESSION SICKNESS.** No matter how careful you are or what equipment you use, there is a risk of decompression sickness (also known as "the bends") any time you dive. The DC-12 Decompression Computer cannot eliminate the risk of decompression sickness, even when you use the DC-12 Decompression Computer properly and follow all instructions precisely. The risk of decompression sickness is part of diving. Before you dive, you must be prepared to recognize the signs and symptoms of decompression sickness and know what to do in case of decompression sickness. **DECOMPRESSION SICKNESS CAN RESULT IN SERIOUS INJURY OR DEATH. DO NOT DIVE UNLESS YOU KNOW AND UNDERSTAND THE RISKS OF DIVING AND ACCEPT THE RESPONSIBILITY ASSOCIATED WITH THOSE RISKS.**

4

- 3. THE DC-12 DECOMPRESSION COMPUTER IS TO BE USED ONLY BY CERTIFIED DIVERS.** Safe diving requires training. **DO NOT** dive unless you have taken and passed a certified diver training course. Such courses are offered by NASDS, NAUI, PADI, SSI, YMCA, and other recognized diver training groups. There are also special courses available in the use of dive computers. We highly recommend the completion of such a course prior to using the DC-12 Decompression Computer.

- 4. REDUCE RISK BY BEING CONSERVATIVE IN YOUR DIVING.** No dive computer or dive table can guarantee against decompression sickness. **TO REDUCE THE RISK OF DECOMPRESSION SICKNESS, DIVE WELL WITHIN THE LIMITS ESTABLISHED BY THE DC-12 DECOMPRESSION COMPUTER. BE CONSERVATIVE WHEN DIVING.**

- 5. STAY WELL WITHIN SAFETY MARGINS.** The DC-12 Decompression Computer provides the diver with information regarding no-stop time, ascent rate and wait-to-fly times. These are model limits designed to protect the majority of divers from experiencing decompression problems during most dives. However, no two people are exactly alike, and studies have shown that certain individuals are more susceptible to decompression problems. **TO REDUCE THE RISK OF DECOMPRESSION SICKNESS, DIVE CONSERVATIVELY. STAY WELL WITHIN ALL SAFETY MARGINS.**

- 6. DO NOT DESCEND BELOW 100 FEET (30 METERS) ON ANY DIVE.** Even though the DC-12 has the capability of operating to greater depths, most recognized diving authorities and diver certifying agencies recommend that sport divers, even those with advanced diver training restrict their diving to less than 100 feet. Sport divers with limited experience should follow the more conservative guideline of 60 feet (18 meters) maximum.

5



**7. THE DC-12 DECOMPRESSION COMPUTER SHOULD NOT BE RELIED ON AS THE ONLY MEANS OF PLANNING AND MONITORING A DIVE.** Use backup equipment for each dive and regularly check backup equipment to ensure that it is operating properly. Buddy diving provides you with a complete set of redundant equipment such as a second computer, watch, depth gauge or dive tables.

**8. WHEN ASCENDING FROM ANY DIVE, MAKE A SAFETY STOP IN THE 10-30 FOOT (3-9 meter) ZONE FOR AT LEAST 3-5 MINUTES.** Such a precautionary stop will reduce, but not eliminate, the risk of decompression sickness. This precautionary stop is absolutely essential for all repetitive dives to 60 feet (18 meters) or greater. However, we strongly recommend a precautionary stop for all dives.

**9. IF YOU HAVE DIVED WITHOUT THE DC-12 DECOMPRESSION COMPUTER DURING THE PRECEDING 24 HOURS, DO NOT BEGIN USING THE DC-12 DECOMPRESSION COMPUTER.** The readings provided by the DC-12 Decompression Computer will be inaccurate if the tissues in your body contain nitrogen from a previous dive not included in the dive history of the DC-12 Decompression Computer. Therefore, before you begin using the DC-12 Decompression Computer, make sure you have not dived anytime during the previous 24 hours without use of the DC-12 Decompression Computer.

**10. IF YOU VIOLATE THE DISPLAY GUIDELINES, SUCH AS EXCEEDING THE ASCENT RATE OR IGNORING THE DECOMPRESSION STOPS, DO NOT DIVE AGAIN FOR AT LEAST 24 HOURS.** The DC-12 Decompression Computers operate on the assumption that you have followed the instructions provided by the DC-12. If you violate the DC-12 guidelines, the information provided by the DC-12 Decompression Computer will no longer be accurate.

**11. LIMIT REPETITIVE DIVING.** There is much still to be learned about the effects of repetitive diving. What is known, however, is that you must be conservative and approach repetitive diving with extreme caution. Follow these guidelines with respect to repetitive diving:

- a. Limit repetitive dives to 100 feet (30 meters) or shallower.
- b. Limit repetitive diving to 3 dives per day.
- c. Do not exceed an ascent rate allowed by the DC-12 Decompression Computer:
  - ascent rate 50 ft/min (15 m/min) in the depth range 0-50 ft (0-15 m)
  - ascent rate 70 ft/min (21 m/min) in the depth range 50-100 ft (15-30 m)
  - ascent rate 90 ft/min (27 m/min) at depths below 100 ft (30 m)
- d. Always put the deepest part of your dive profile at the beginning of the dive time and gradually proceed to shallower depths.
- e. Avoid "saw-tooth" diving, that is, bouncing from shallower to deeper depths within the course of a dive.
- f. Remember, deep repetitive dives are for trained, experienced experts only.

**12. MAKE THE FIRST DIVE OF THE DAY THE DEEPEST DIVE. DURING EACH DIVE, START DEEPER AND WORK SHALLOWER.** This allows nitrogen to outgas from the body as the dive or dives progress. Diving shallow and then deeper increases the risk of decompression sickness.

**13. DO NOT ATTEMPT HIGH ALTITUDE DIVING UNLESS YOU HAVE RECEIVED SPECIAL TRAINING.** There is much still to be learned about high altitude diving. The DC-12 Decompression Computer is designed for use in high altitude diving. However, be cautious and conservative about diving in high altitudes. **DIVE WELL WITHIN SAFETY MARGINS.**



**14. DO NOT FLY FOR 24 HOURS AFTER DIVING OR WAIT UNTIL THE DC-12 DECOMPRESSION COMPUTER INDICATES IT IS SAFE.** Do NOT fly until the DC-12 indicates that it is safe to fly. This is indicated by the absence of the DO NOT FLY symbol on the left side of the display when the unit is turned on. If at all possible, wait 24 hours after the last dive before flying.

**15. ALWAYS DIVE WITH A PARTNER.** Not only a must in terms of safety, buddy diving is also more enjoyable.

**16. DO NOT DIVE WITH THE DC-12 IF THE DISPLAY CONTRAST APPEARS WEAK OR FADED.** This indicates that battery is weak and needs to be returned to Scubapro for service.

**17. IF THERE ARE ANY INDICATIONS THAT THE DC-12 DECOMPRESSION COMPUTER IS PROVIDING INACCURATE READINGS OR IS NOT FUNCTIONING PROPERLY IN ANY OTHER FASHION, IMMEDIATELY STOP YOUR DIVE.** Have the DC-12 Decompression Computer immediately returned to SCUBAPRO directly or through your Authorized SCUBAPRO Dealer. Include an explanation of the problems you experienced. Never dive with equipment you believe may be faulty. Use common sense.

**18. THIS PROGRAM VERSION OF THE DC-12 IS DESIGNED FOR SCUBA DIVING ONLY, WITH COMPRESSED AIR ONLY AND WILL NOT PREDICT DECOMPRESSION STATUS CORRECTLY FOR ANY OTHER GAS MIXTURES.**

## IV. DISSOLVED GAS THEORY

The DC-12 utilizes the dissolved gas theory to predict what happens in your body during a dive or series of dives. It simulates the nitrogen absorption during a dive, and nitrogen elimination during ascent and while on the surface.

Absorption of nitrogen is called in-gassing and occurs as more nitrogen is forced into body tissues as you dive deeper and/or stay longer. Elimination of nitrogen is referred to as outgassing and occurs when the ambient pressure is less than the pressure of nitrogen in solution within the body tissue.

The DC-12 decompression algorithm computes partial pressures of dissolved nitrogen in the human body, which is modeled by 9 compartments ('tissues') with half times of approx. 5-700 minutes. Outgassing is retarded, according to the amount of bubbles to be expected after the preceding dive(s). Excessive bubble growth during ascent from very deep dives (inadequately covered by some models) leads to more conservative decompression. The same applies to repetitive dives deeper-than-previous as long as bubbles are expected to be present after the preceding shallower dive.

The following table lists the scrolling single-dive, no-decompression limits of the DC-12.

DEPTH (ft)	41	51	61	71	80	90	100	110	120	130	139	140
TIME (mins.)	99	55	34	25	19	15	13	11	10	9	8	7

Table 1  
Single dive no-decompression time limits



## V. FUNCTIONS

The following functions and readouts are part of the DC-12 Decompression Computer automatic calculations and measurements:

### General Functions

1. Self Test
2. Elapsed dive time
3. Program mode indicators
4. Air temperature
5. Current depth
6. Maximum depth
7. Ascent rate warning
8. Warning when flying after diving is not allowed
9. Waiting time before flying
10. Decompression status
11. Dive counter
12. Accumulative dive hour counter
13. Permanent record of maximum depth ever reached
14. REP. indicator for repetitive diving
15. Surface interval log for up to six dives per day
16. Maximum depth and total dive time log for six dives per day
17. Scrolling no-decompression times for 41-149 feet (12-45m)
18. Out-of-range mode

### Decompression Functions

19. Remaining no-decompression time (digital and graphic)
20. Graphic warning when approaching no decompression time limit.
21. Graphic warning when decompression stops are necessary
22. Decompression stop depth and total ascent time.
23. Shallowest depth allowed (ceiling depth)
24. Graphic warning if ceiling depth is exceeded.
25. Emergency mode with scrolling decompression plan

### High Altitude Functions

26. User selected decompression program for high altitude diving to 8,200 feet (2500 meters)
27. Usable as a depth gauge only at altitudes from 8,200 to 13,000 feet (2,500-4,000 meters)
28. Mountain symbol to indicate high altitude decompression mode.

### Dive Planning

29. Dive planner for calculating dive profiles or demonstration.
30. Scrolling no-decompression times for dive planning.





## VI. DISPLAY

The DC-12 display is especially designed to be logical, easy to understand and intuitive to the user. The display itself is a high contrast Liquid Crystal Display (LCD). The two opposing diagonal lines printed across the display divide it into four corners of information, with a large depth display in the center. Behind these printed diagonals are two bold LCD arrows that will appear in certain circumstances to advise the diver to either ascend or descend. The display areas are reserved for the following information:

Center: depth, temperature, no-deco time graphic  
 Upper left corner: decompression stop depth.  
 Upper right corner: total elapsed dive time  
 Lower right corner: mode indicators  
 Lower left corner: no deco time or total decompression stop and ascent time (only when in decompression mode)

Figure 2 shows the maximum potential of what can appear in each display area. All elements would only be seen during the start up self-test.

- |   |                                  |
|---|----------------------------------|
| 1. No-Decompression/<br>decompression graphic | 11. Minutes or hours indicator   |
| 2. Elapsed dive time                          | 12. No-deco or total ascent time |
| 3. No Fly indicator                           | 13. Maximum depth indicator      |
| 4. Decompression indicator                    | 14. Total ascent time symbol     |
| 5. Feet or meters indicator                   | 15. Temperature indicator        |
| 6. On-sensors                                 | 16. Depth                        |
| 7. Mode indicators                            | 17. Command Arrow (go up)        |
| 8. Repetitive dive indicator                  | 18. Out of range                 |
| 9. Command Arrow (go down)                    | 19. Decompression stop depth     |
| 10. Wrist strap                               | 20. Dive number (log book)       |

12

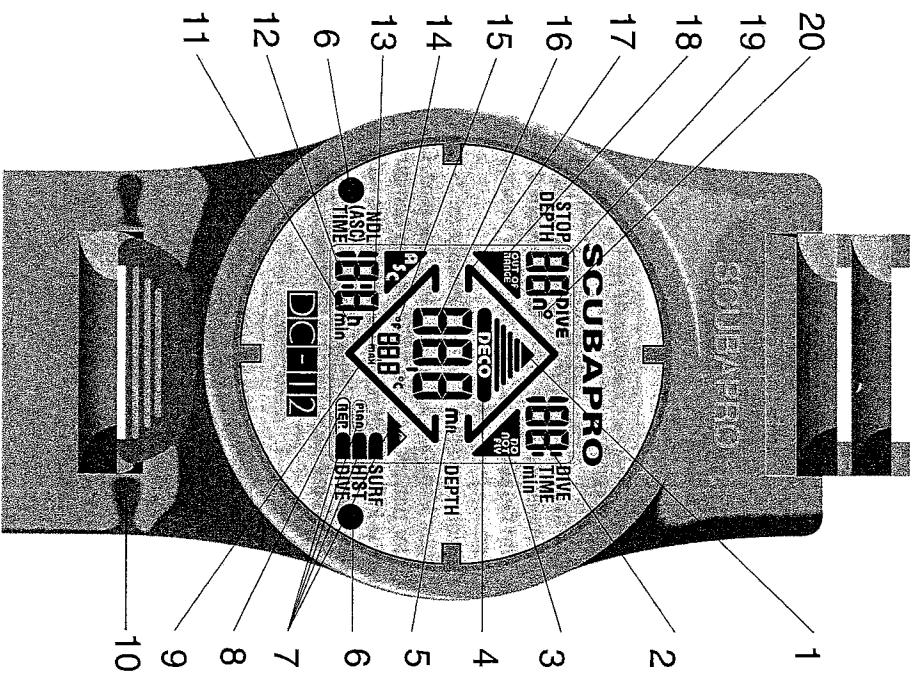

Figure 2  
Master Display

13



## VII. COMPUTER OPERATION

The DC-12 Decompression Computer has four basic modes of operation:

1. Sleep Mode
2. Surface Mode
3. History Mode
3. Dive Mode

### Selecting Programs

On the face of the DC-12 are two metal contacts (On-Sensors), that when bridged by moisture (placed in water or touched with moistened fingertips) will turn the unit on or allow the diver to access the various program functions.

Each time you activate these On-Sensors for 1-2 seconds, you move the computer from one program step to the next. Contacting the sensors for longer periods of time will jump the computer to different modes as describe in the master program chart. We will describe each program step by step in the following pages.

To assist you in the Programming Selections, keep these guidelines in mind:

1. If the DC-12 is in the *SLEEP MODE* (blank display), the computer can be activated by briefly touching the On-Sensors for 1-2 seconds. The computer will automatically return to the sleep mode to conserve battery life after 4 minutes 15 seconds if the on-sensors are dry and the computer is undisturbed.
2. When immersed in water, the computer will switch to and remain in the dive mode. No other programs may be accessed in the dive mode, and contact of the on-sensors when in the dive mode will have no effect.

14

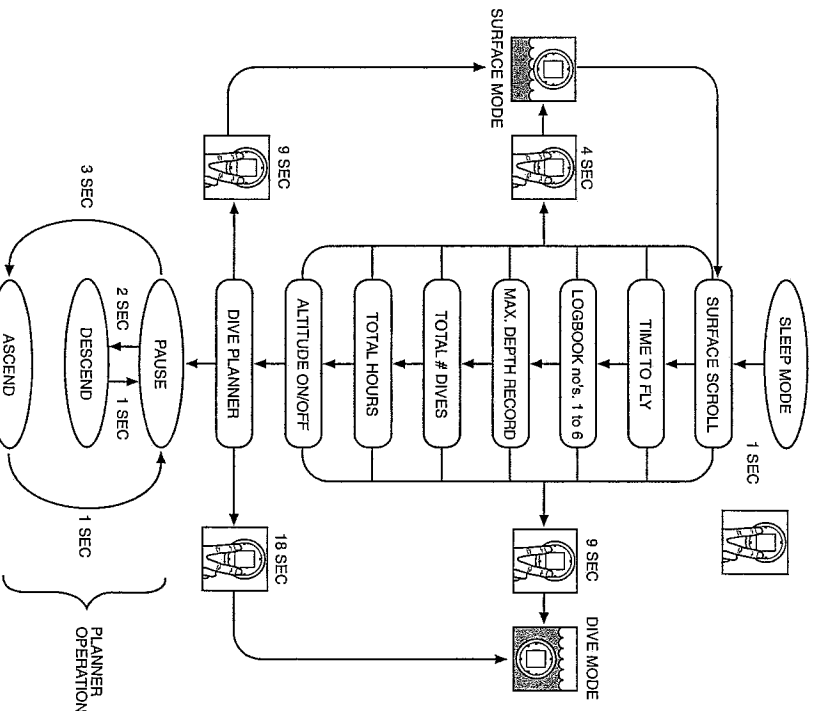

Chart 1  
Master program

15



- When on the surface, in the *SURFACE* or *HISTORY* modes the program being displayed will move one level to another each time the On-Sensors are activated for 1-2 seconds. Each activation will sequence you through to the next program step.
- If the On-Sensors are touched for 4 seconds in any mode except the *DIVE PLANNER* and *DIVE MODE*, the computer returns to the *SURFACE MODE* and resumes scrolling the No-Decompression Times. If the On-Sensors are touched for longer than 9 seconds, the DC-12 will switch to the *DIVE MODE*. Surface mode program selections may be resumed by activating the On-Sensors 1-2 seconds.
- When in the *PLAN MODE*, touching the on-sensors for 9 seconds will return the computer to the *SURFACE MODE* and touching the sensors for 18 seconds will return it to the *DIVE MODE*.
- Once in the *DIVE MODE*, if no dive is made within 4 minutes and the On-Sensors are dry, the computer automatically returns to the *SURFACE MODE*.

### 1. Sleep Mode

If the display of the DC-12 appears blank, it's probably in the Sleep Mode. If the DC-12 is not actively being used, it will go into the Sleep Mode after 4 minutes 15 seconds. The display will become blank as the DC-12 conserves battery power. To activate the display, immerse the DC-12 into the water or touch the On-Sensors (two metal pins beneath the display) simultaneously with moistened fingers for 1-2 seconds. This activates the computer and zeroes the depth. For this reason, the DC-12 should always be activated on the surface prior to diving. Descending into the water immediately from the sleep mode could cause the zero point of the depth gauge to be in error.

After activation, the DC-12 display flashes, the computer goes through a self test and then moves into the surface mode, indicated by the SURF indicator in the display.

## 2. Surface Mode

### a. Scrolling No-deco Times

The starting point of the surface program is the Surface Mode Scroll. This program appears automatically whenever the DC-12 is activated from the Sleep Mode, or four minutes after exiting the water from a dive. Based on your saturation level from previous dives, the Surface Mode Scroll will display the **no-deco time limits from 41 to 149 feet (12-45 meters)** (fig. 3).

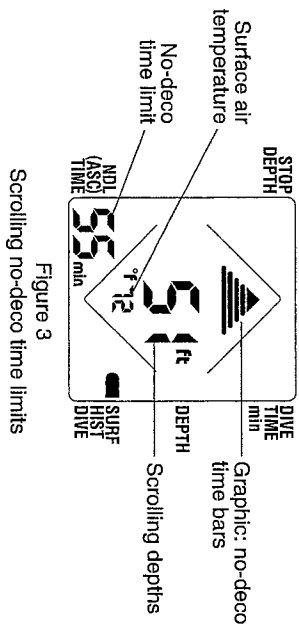

### Graphic Triangle

The triangular bar graph above the depth display is a graphic representation of the no-deco time limit. If all four bars are displayed, at least 30 minutes of time remains. As the time limit decreases, the bars disappear in order from the largest to smallest. The number of bars will increase or decrease in relationship to the digital no-deco time shown in the lower left corner of the display. This provides the diver with a quick reference to no-decompression time status. **THIS GRAPHIC WILL FLASH AND CHANGE TO REPRESENT TOTAL DECOMPRESSION TIME REQUIRED IF DECOMPRESSION STOPS ARE NECESSARY.** (See also section 4-h.)



### b. Time Before Flying

The next program step (1-2 second contact) is the wait time before flying. It is important to know how long it takes before it is safe to fly after your last dive. The DC-12 will display the abbreviation **FLt** in the center display with the number of hours before flying is allowed in the lower left corner. The **DO NOT FLY** symbol appears in the upper right of the display. The **REP** (repetitive dive) indicator in the lower right appears whenever there is still tissue saturation remaining from a previous dive that has not completely cleared (fig. 4).

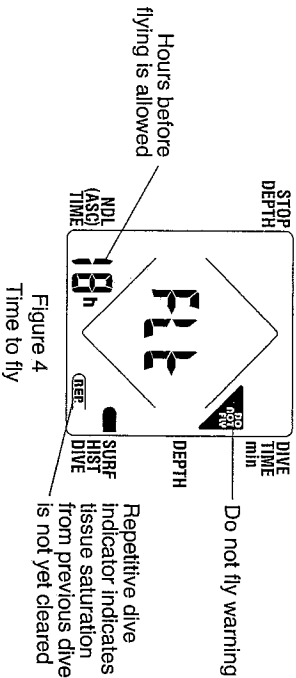

Figure 4  
Time to fly

### 3. History Mode

#### a. Dive Logbook and Surface Interval

The next program step (1-2 second contact) switches the program to the History Mode, note the mode indicator has switched to **HIST** in the lower right corner of the display (fig. 5). The DC-12 logbook and dive recorder stores and allows you to recall the elapsed dive time, maximum depth and surface interval for the last six dives made. These dives can be recalled at any time when in the surface mode until they are automatically replaced by more recent dives.

### NOTE

1. The dive time is more than 10 minutes.
2. The dive time is more than 5 minutes and the maximum depth is more than 17 feet.

The information is presented in an alternating display. The dive number (Dive no. 1 being the most recent) is displayed with elapsed dive time, maximum depth and the abbreviation **LOG** (fig. 5). This is displayed for 2 seconds, then the surface interval in hours and tens of minutes is shown with the abbreviation **Int** (fig. 6). The logbook begins with the most recent dive and sequences back through the previous 5 dives each time the sensors are contacted.

#### b. Maximum Depth

The next program step (1-2 second contact) displays the maximum depth ever reached in any dive by the DC-12 (fig. 7). The abbreviation **d-r-c-d** max appears on the display.

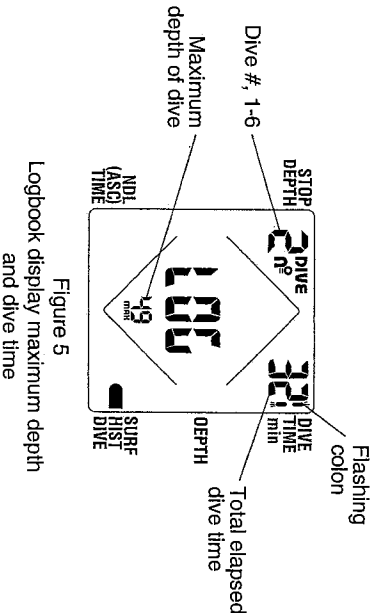

Figure 5  
Logbook display maximum depth and dive time

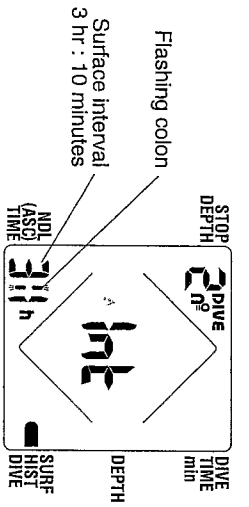

Figure 6  
Logbook display-surface interval  
in hours and tens of minutes

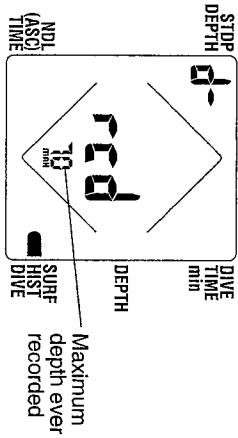

Figure 7  
Maximum depth ever reached

### c. Total Dives

The next program step (1-2 second contact) displays the total number of dives ever made using the DC-12. The abbreviation **no rcd** appears on the display (fig. 8).

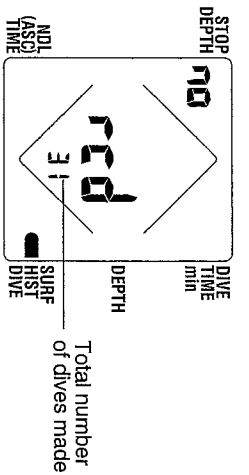

Figure 8  
Total number of dives made

### d. Total Dive Hours

The next program step (1-2 second contact) is the total hours of active operation of the DC-12. The DC-12 keeps track of the total number of dive hours accumulated and is shown in the display with the abbreviation **hr rcd** (fig. 9).

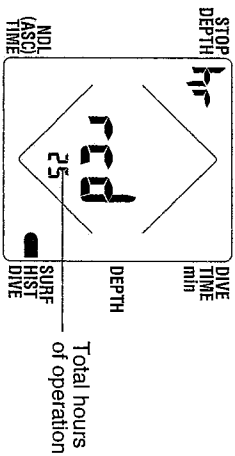

Figure 9  
Total hours record



### e. Altitude Program

The next program step (1-2 second contact) is the altitude selection program. The display will alternate **Alt on** and **Alt off**. To select which program is to be used, simply contact the sensors again when the appropriate program is shown (on or off) to lock in the program, and advance to the next program step (figs. 10,11). If the **Alt on** is selected, the mountain symbol will appear on the display whenever in the dive mode or when simulating a dive in the planner.

The DC-12 will automatically default to the sea level (Alt off) program 17 hours after all tissues are cleared. Once the altitude program is selected and a dive is made, the program cannot be changed again until the fly time is zero (tissues are cleared).

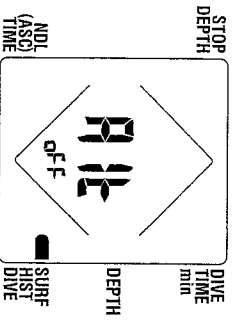

Figure 10  
Altitude program off  
(sea level)

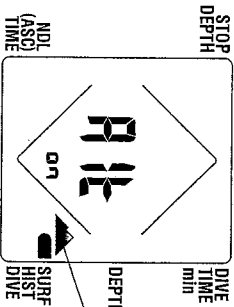

Figure 11  
Altitude program on

### WARNING

YOU SHOULD NOT DIVE AT HIGH ALTITUDE UNLESS YOU HAVE COMPLETED A SPECIAL COURSE IN HIGH ALTITUDE DIVING. DIVING WITH THIS COMPUTER ABOVE ALTITUDES OF 2,300 FEET (700 METERS) REQUIRES MANUAL SELECTION OF THE HIGH ALTITUDE PROGRAM AND KNOWLEDGE ABOUT ITS PROPER USE. PLEASE REFER TO THE SPECIAL SECTION ON HIGH ALTITUDE DIVING IN THIS MANUAL FOR FURTHER INFORMATION.

### f. Dive Planner

The dive planner is the next program step (activated by 1-2 second contact) and is displayed with the abbreviation **Pln**. The Dive Planner function of the DC-12 allows you to answer the question of "What if?" This is one of the many outstanding features of the DC-12. Being able to plan dives and predict decompression requirements for various possible dives gives you the ability to examine the various dive profiles for the next dive. **The planner forecasts the next dive based on your current nitrogen saturation level.**

### NOTE

*If you want to skip the Dive Planner, touch the On-Sensors for 9 seconds after "Pln" is displayed, the computer will switch to the SURFACE MODE. Touching the On-Sensors for 18 seconds will return to the DIVE MODE. (See Chart 1, pg. 15)*

When the abbreviation **Pln** is displayed, (fig. 12) the planner is ready for activation. Touch the on-sensors again 1-2 seconds. The next display (fig. 13) appears as the computer would on a real dive except for the **PLAN** indicator in lower right corner. The display will simulate exactly as the real dive would occur.

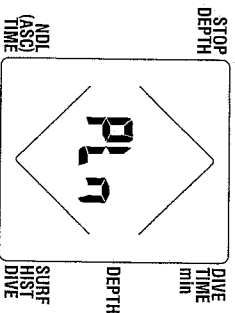
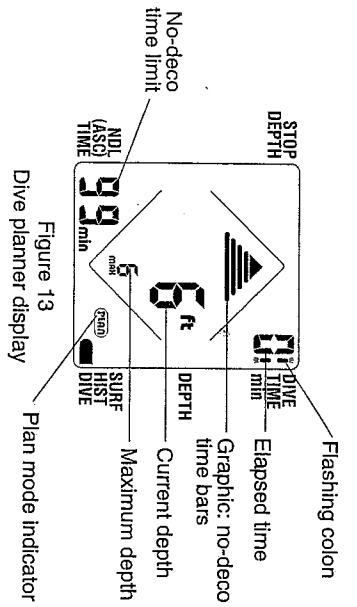

Figure 12  
Starting point of  
dive planner display



1. The Dive Planner can be activated only when PLN is displayed.
2. The DC-12 is now ready to simulate and display any dive profile for most realistic diving conditions. The computer simulates the dive based upon your actual tissue saturation.
3. The simulation begins by touching the On-Sensors for two seconds. This starts the simulation by descending in real time at 100 feet per minute (30m/min).
4. To stop the descent and maintain a constant depth, the On-Sensors must be touched again for 1 second. The elapsed dive time is accelerated to 12 times faster than real time, that is 1 minute of dive time will only take 5 seconds.
6. The descent may be resumed any time by touching the On-Sensors again for 2 seconds.
7. To ascend, maintain touch with the On-Sensors 3 seconds. The display will start to descend, then reverse direction and begin ascending. To stop the ascent again, touch the On-Sensors 1 second. The ascent is made at 50 feet per minute (15m/min).

8. If the On-Sensors are touched longer than 9 seconds, the computer turns off the Dive Planner and returns to the surface scroll mode.
9. If the On-Sensors remain touched longer than 18 seconds, the DC-12 switches into the DIVE MODE. This built-in automatic safety feature assures you the DC-12 will be in the correct Mode when diving.
10. A light touch with wet fingers is all that is necessary to activate the On-Sensors.
11. Another much simpler way to judge the time required when touching the On-Sensors is to observe the display and just touch the On-Sensors until you see the first depth increase or decrease, then remove your fingers from the Sensors at once.
12. Table 2 summarizes the commands for the dive planner.

Table 2 Commands and Contact Times: Dive Planner

Command	On-Sensor Contact Time
Descend at 100 ft/min	Touch 2 seconds
Pause (maintain depth)	Touch 1 second
Ascend at 50 ft/min	Touch 3 seconds
Surface Mode (scroll)	Touch 9 seconds
Dive Mode	Touch 18 seconds or longer

**IMPORTANT NOTE**

The dive planner will not return to the Sleep Mode automatically until 199 minutes appear in the elapsed time window. If you have finished with the planner, to conserve battery life, touch the on sensors for 9 seconds to return to surface mode.



#### 4. Dive Mode

##### a. Computer Activation

When the DC-12 is immersed in water or the On-Sensors are touched for more than 9 seconds, the display automatically enters the Dive Mode (fig. 14).

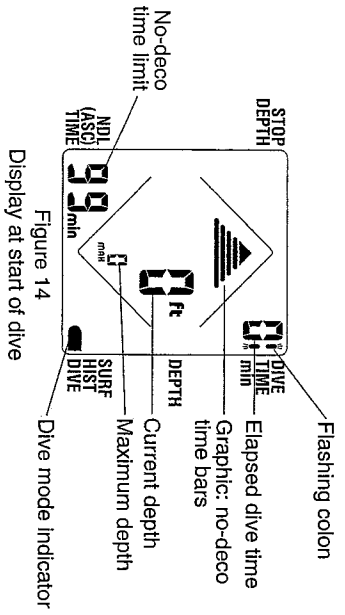

##### WARNING

**YOU SHOULD ALWAYS ACTIVATE THE DC-12 BEFORE ENTERING THE WATER.** The DC-12 requires a 5-second cycle time to conduct a self-test and zero the depth gauge. Should you descend below the surface during those 5 seconds, the zero point used by the computer may not be at the surface. Your actual depth will be slightly deeper than what appears on the display. Pre-wet the On-Sensors and wait about 10 seconds near the surface before descending.

##### b. Dive Time

The Dive Time appears in the upper right corner of the display. (fig. 15). The dive time starts when you descend below 4.5 feet (1.3 m) and stops when you ascend above 4.5 feet.

##### c. Current Depth

The Current Depth is displayed as the large, prominent digits in the center of the display. A *ft* or *m* indicator indicates if the gauge is a feet or meters version (fig. 15).

##### NOTE

The maximum depth limitation of the DC-12 is approximately 297 feet (90 meters). The decompression algorithm is no longer valid below the depth, and the depth display will freeze at approximately 305 feet (93 meters) until a shallower depth is reached.

##### d. Max Depth

The max depth of the dive is displayed in smaller digits immediately below the current depth with the abbreviation **max** (fig. 15).

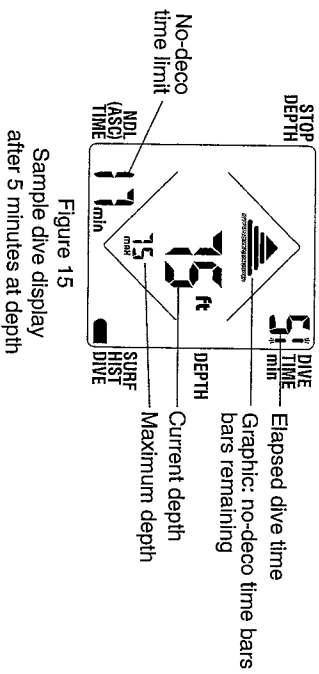





### e. No Decompression Time

In the Dive Mode, the No-Decompression Time appears as a digital number in the lower left corner of the display. A graphic indication of relative no-deco time is provided with a series of five black bars appearing as a triangle above the current depth of the display (fig. 14). These bars (the triangle) will appear full at the beginning of the dive and disappear as the no-deco time approaches zero (fig. 15). The bars represent from largest to smallest, 30, 15, 8 and 4 minutes.

Ascending or descending will change the No-Decompression Times accordingly. By using the No-Decompression Bar as a guide, you have a quick graphic reference to your relative no-deco time. If you stay within the displayed no-decompression limits, and never allow all of the bars to disappear or the no-deco time to reach zero, you can return to the surface at any time without decompression stops.

## WARNING

**YOU MUST STAY WITHIN THE NO-DECOMPRESSION LIMITS TO AVOID POSSIBLE PROBLEMS.** Only divers who have completed a course in advanced decompression diving techniques should go beyond the no-decompression limits. Even qualified divers should use extreme care to prevent decompression problems.

### f. Decompression

When you approach the no-decompression limit of 3 minutes, the graphic no-deco time bars beneath the triangle will have disappeared down to the last bar. The last bar and top of the triangle will flash to warn that you are nearing the no-deco time limit (fig. 16). When the no-deco time limit reaches 1 minute, all bars will have disappeared and only the top of the triangle remains flashing. If you remain at depth, the no-deco limit will reach zero time remaining and the display will change to indicate decompression is required.

To avoid decompression, ascend to a shallower depth. The triangle symbol will stop flashing and additional bars may be added to the triangle as your depth decreases. The display will significantly change appearance when decompression is required (fig. 17).

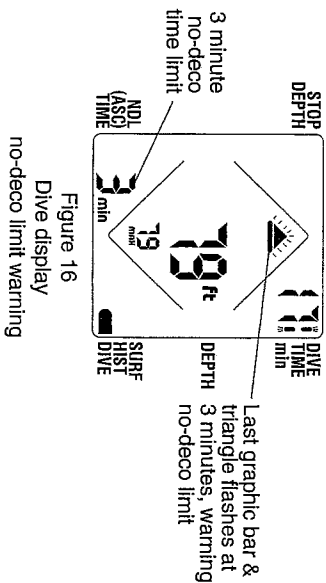

### g. DECO and ASC (ascent) Symbol

When a decompression stop is required, the DECO symbol will remain on continuously and the symbol ASC will appear near the time window that was previously reserved for no-deco time (fig. 17). The numbers in the lower left window now indicate total ascent time (ASC). Total ascent time is the total of the decompression stop times and the time to travel through the water (at an ascent rate of 33 feet per minute) to safely ascend to the surface. This is a forecast of the minimum amount of time it should take you to make all of the decompression stops and swim to the surface.



### h. Graphic Triangle

The triangular bar graph now represents the **total ascent time (total decompression time plus ascent time) required** and will flash continuously to alert the diver to the decompression requirement. The number of bars in the triangle will increase as the ascent time and decompression debt increases. This provides the diver with a quick reference to decompression status and the flashing will constantly remind you that you are in the decompression mode.

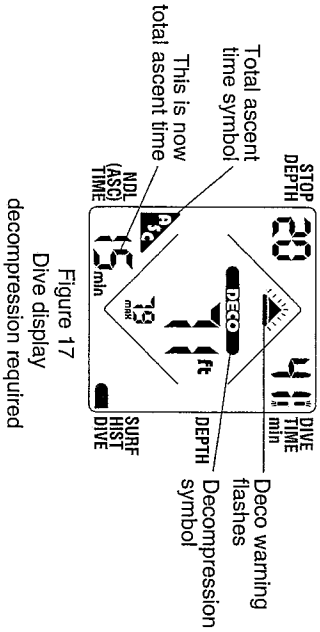

Figure 17  
Dive display  
decompression required

### i. Deco-Stop Depth

The current deepest decompression stop depth is indicated in the upper left of the display. You must stop as close to the decompression depth as possible to optimize your decompression (fig. 17).

### j. Command Arrows

The bold up or down command arrows in the center of the display will help guide you through your decompression stops. If you ascend too quickly, the **down** arrow will appear to indicate you should slow your ascent. When you reach correct deco-stop depth, **both** arrows will appear. This means "stay where you are" (fig. 18). You have reached the proper decompression stop depth indicated on the display (upper left

corner) and must maintain this depth until you have finished your time at this stop depth. The arrows will remain on when you are in the correct deco-stop depth range until you have completed your decompression stop, then the arrows will disappear, and you may ascend to the new stop depth. If you violate the deco-stop depth the down arrow will appear, and flash to warn you to descend immediately (fig. 19a). **NEVER RISE ABOVE THE INDICATED DECO-STOP DEPTH OR IGNORE THE COMMAND ARROWS.**

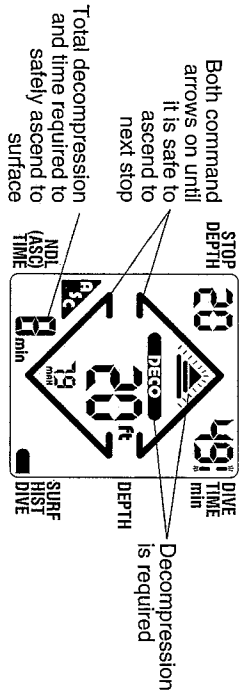

Figure 18  
Decompression display  
"Stay where you are"

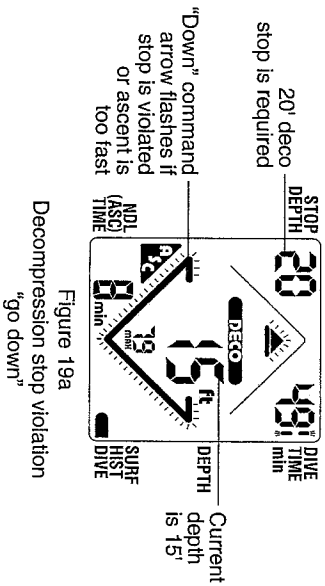

Figure 19a  
Decompression stop violation  
"go down"



### k. Ceiling

During decompression, the stop depth is always displayed in 10 foot increments (10, 20, 30 etc.). The actual ceiling however is constantly changing depending upon your decompression status. For this reason, the "stay where you are" arrows may give you considerable latitude in your actual decompression stop depth. If you do ascend above the actual ceiling, the down arrow will appear and flash, and the actual ceiling depth will appear in the deco-stop depth window until you descend to this depth. This number is the minimum ceiling depth. You must descend below this depth to complete decompression. Descend immediately to this depth, and observe the command arrows (fig. 19b).

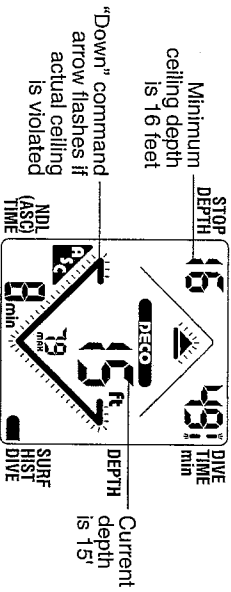

Figure 19b  
Violation of actual ceiling depth

### WARNING

DURING THE DECOMPRESSION PHASE OF THE DIVE MODE, YOU MUST MONITOR THE DC-12 CONTINUOUSLY TO AVOID MISSING A DECOMPRESSION STOP. IF YOU MISS A DECOMPRESSION STOP, THE DOWN ARROW WILL FLASH UNTIL YOU DESCEND TO THE PROPER DECOMPRESSION DEPTH.

### WARNING

IF YOU SURFACED AFTER SKIPPING DISPLAYED DECOMPRESSION STOPS AND TIMES (FOR WHATEVER REASON) WE STRONGLY RECOMMEND BREATHING PURE OXYGEN, ADMINISTERED BY A QUALIFIED ATTENDANT, AND DRINKING ABOUT ONE PINT OF WATER TO PREVENT DEHYDRATION. THIS ALSO APPLIES IF (ALTHOUGH OBEYING ALL DECOMPRESSION RULES) SYMPTOMS OF DCS DEVELOP AND IMMEDIATE MEDICAL SUPERVISION IS NOT AVAILABLE. YOU SHOULD CONSIDER SEEKING QUALIFIED SURFACE RECOMPRESSION TREATMENT, ESPECIALLY IF DECOMPRESSION SICKNESS SYMPTOMS APPEAR.

### WARNING

YOU MUST KEEP IN MIND THAT THE SUSCEPTIBILITY TO DECOMPRESSION SICKNESS (DCS) VARIES WIDELY AMONG INDIVIDUALS AND ALSO FROM DAY TO DAY. NEVERTHELESS, IF YOU KEEP TO THE RULES DISPLAYED BY YOUR DC-12 AND TO CONSERVATIVE PROCEDURES IN GENERAL, THE REMAINING RISK OF DECOMPRESSION SICKNESS (DCS) IS VERY SMALL ALTHOUGH NEVER EXACTLY ZERO.

#### 1. Ascent Rate

If you ascend too fast, an arrow pointing down will flash to warn you to slow your ascent rate in the same manner as violating a decompression stop. (See fig. 19) The ascent warning does depend on the depth. The DC-12 is programmed to allow you to ascend slightly faster from greater depths and slower from shallower depths.

Ascending slightly faster from deeper depths prevents additional accumulation of nitrogen during the ascent. The Slow Ascent warning schedule is as follows:

- ascent rate 50 ft/min (15 m/min) in the depth range 0-50 ft (0-15 m)
- ascent rate 70 ft/min (21 m/min) in the depth range 50-100 ft (15-30 m)
- ascent rate 90 ft/min (27 m/min) at depths below 100 ft (30 m)



#### m. Out of Range

There are several things that will put the DC-12 into an Out of Range condition:

1. If decompression is required and the total ascent time reaches 49 minutes, the OUT OF RANGE symbol will appear and flash. As long as it is flashing, the DC-12 is nearing an out of range condition and can still be used if the required decompression schedule is started immediately.
2. If the total ascent time reaches 90 minutes, the OUT OF RANGE symbol will remain on permanently and the computer will remain in the out of range mode. In the OUT OF RANGE MODE, the DC-12 will no longer compute decompression, but will only operate as a depth gauge and dive timer. The last required decompression depths and times before entering out of range will be scrolled on the display in the stop depth and ASC time windows.
3. If the decompression stop is ignored, the DC-12 will go into of OUT OF RANGE mode.

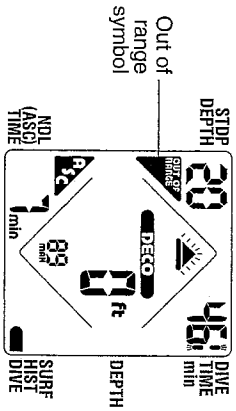

Figure 20  
Out of range

4. If the decompression stop depth is greater than 88 feet (27 meters), the DC-12 will go into OUT OF RANGE mode.
5. Any out of range dive will be stored in the logbook and the OUT OF RANGE symbol displayed when the dive is recalled.

#### WARNING

IF THE OUT OF RANGE SYMBOL IS DISPLAYED WHILE DIVING, YOU MUST IMMEDIATELY GO TO THE DISPLAYED DEPTH FOR THE DECOMPRESSION TIME INDICATED. IN ANY SITUATION WHERE DECOMPRESSION HAS BEEN MISSED OR THE OUT OF RANGE SYMBOL IS STILL DISPLAYED, THERE IS A RISK OF DECOMPRESSION SICKNESS AND THE DIVER'S CONDITION SHOULD BE CAREFULLY CHECKED FOR THE NEXT 24 HOURS. DO NOT MAKE FURTHER DIVES DURING THAT TIME. IMMEDIATE TREATMENT SHOULD BE ADMINISTERED BY QUALIFIED RECOMPRESSION SPECIALISTS AND FACILITIES.



**n. Between Dives**

When you reach the surface after the first dive, the DC-12 Decompression Computer automatically does several things:

1. The Dive Time Clock stops when you ascend above 4.5 feet (1.3 m)
2. If you **DO NOT** dive again within 4 minutes and are shallower than 4.5 feet, the computer will enter the dive into the electronic logbook and display the *REP.* symbol in the display to show that a previous dive has been made, and some level of tissue saturation exists.
3. If you **DO** go back down within 4 minutes, the computer will continue the Time Clock as part of the first dive, as if there had not been a surface interval. This is an added safety feature.
4. Four minutes after you get out of the water, the computer switches over to the *SURFACE MODE* (the two contacts must be dry for a full 4 minutes).

**NOTE**

The DC-12 Decompression Computer contacts **MUST BE** dry and clean after surfacing to enter the surface mode. Do **NOT** put the computer near other wet diving equipment or other wet objects. This is vital, because if there is an electrical contact between the On-Sensors, the computer will not know that it is out of the water and will not switch to the *SURFACE MODE* to begin counting the surface interval time. If this should happen, the computer will calculate the desaturation of the tissues correctly, but will never enter surface mode or enter sleep mode to conserve battery power. The surface interval time should be used as reference only. The DC-12 will terminate surface interval timing when either a subsequent dive is commenced or all tissues are desaturated to ambient condition.

**o. Repetitive Dives**

For the second and later dives (repetitive dives), the DC-12 automatically makes adjustment for increased residual saturation and desaturation of the body tissues and adjusts the No-Decompression Times displayed accordingly. The *REP.* symbol appears in the lower right corner of the display and remains visible until all tissues are desaturated back to approximate atmospheric nitrogen partial pressure again (fig. 21).

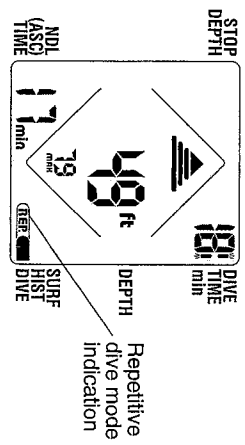

Figure 21  
Repetitive dive mode

**WARNING**

THE DC-12 DECOMPRESSION COMPUTER DOES NOT AND CAN NOT INCORPORATE VARIABLES FOR INDIVIDUAL DIVERS.



## VIII. SPECIAL DIVING CONDITIONS

### 1. HIGH ALTITUDE DIVING

#### WARNING

YOU SHOULD NOT DIVE AT HIGH ALTITUDE UNLESS YOU HAVE COMPLETED A SPECIAL COURSE IN HIGH ALTITUDE DIVING. YOU MUST SWITCH THE DC-12 PROGRAM TO HIGH ALTITUDE MODE IF DIVING ABOVE 2,300 FEET (700 METERS). SEE SECTION 3-PG. 22. DO NOT SWITCH TO HIGH ALTITUDE MODE UNTIL YOU REACH THE DIVE SITE.

Because of the difference in decompression schedules between sea level and high altitude diving, special care must be taken to understand and follow proven high altitude diving practices.

If you are going to be diving at high altitude in mountain lakes above 2,300 feet (700 meters), you need to change the computer from the Sea Level Mode to the High Altitude Mode.

The DC-12 is designed so that the tissue model and safety margins included allow for high altitude (mountain lake) dives up to 8,500 feet (2,500 meters) above sea level. However, extreme care must be taken that the following procedures are followed:

- a. Prior to **each** dive at elevations above 2,300 feet (700 meters), check that the high altitude program is switched ON and indicated by the mountain symbol. The DC-12 will automatically return to sea level program about 17 hours after the high altitude program is switched on if a subsequent dive is not made.
- b. When diving in mountain lakes, it is advisable to keep inside the "No-Decompression time" and not perform decompression dives.
- c. The altitude program cannot be switched back and forth unless all tissues are cleared (**Fit** time is 0 and **Rep** symbol is not displayed).

38

- d. If you have made a dive (or multiple dives) at sea level and are planning a subsequent dive at high altitude dive, you must wait at least 24 hours or until the tissues are cleared (**Fit** time is 0).

- e. The DC-12 may be used as a decompression computer above altitudes of 8,200 feet (2,500 meters) because the program will no longer be valid. It may still be used as a precision depth gauge and dive timer to a maximum altitude of 13,000 feet (4,000 meters).

### 2. GROUP DIVING

#### WARNING

DO NOT USE ONLY ONE DECOMPRESSION COMPUTER WHEN DIVING WITH A GROUP OF DIVERS, BECAUSE OF THE MANY VARIABLES IN THE DIVE PROFILES OF EACH DIVER. EACH DIVER MUST HAVE HIS OR HER OWN DECOMPRESSION COMPUTER.

It is not possible for the DC-12 is to be used by more than one diver the same day. The computer must be totally clear of saturation before it is used by another diver. (The **Do Not Fly** and **Rep** indicators are not displayed). This may take up to 24 hours or more.

#### WARNING

IF THE DC-12 IS LOANED TO SOMEONE, MAKE SURE THEY HAVE NOT DIVED WITHIN THE LAST 24 HOURS AND THE REP INDICATOR IS NOT DISPLAYED WHEN THE COMPUTER IS TURNED ON.

39



### 3. PRESSURE CHAMBER TESTING

The DC-12 Decompression Computer was designed for a maximum pressure limit of 295 feet (90 meters) of seawater. The DC-12 could be damaged under the following conditions:

- a. The DC-12 should **NEVER** be used in a test pressure chamber or decompression chamber without the DC-12 being immersed in about 2 inches of water. If the DC-12 is pressurized in air without being submerged in a small container of water, the air pressure can be forced into the silicone gel surrounding the pressure transducer inside the computer case, destroying it.
- b. Even when in a small container of water, the DC-12 should **NEVER** be exposed to pressures in a chamber higher than the equivalent depth of 197 feet (60 meters). Pressures higher than this will destroy the silicone block inside the computer by diffusion.

### WARNING

**NEVER EXPOSE YOUR DC-12 DECOMPRESSION COMPUTER TO ACTUAL DIVING DEPTHS GREATER THAN 295 FEET (90 METERS) OR PRESSURIZE IT IN A CHAMBER TO DEPTHS GREATER THAN 197 FEET (60 METERS) WITHOUT FIRST IMMERSING IT IN 1-2 INCHES OF WATER.**

### 4. ERROR MODE

Certain circumstances could cause the DC-12 to go into error mode, indicated by E-7 in the display. If this occurs, dry the on-sensors and wait for about 2 hours for the computer to self clear, then restart the computer with the on-sensors.

## IX. CARE AND MAINTENANCE

### 1. BATTERY

The battery life of the DC-12 is dependent upon the amount and frequency of use, therefore it is advised to dry off the on-sensors to allow the computer to go into the sleep mode whenever it is not being used to conserve battery power. It is a Lithium battery with an approximate 10 year shelf life. It is sealed into the case to prevent any possibility of leakage and can only be replaced by the factory.

The actual service life will be a result of the frequency of use and the relative age of the battery. If the DC-12 is used frequently, it has the capacity for about 8 years of diving (at 70 dives per year). In extreme use, you should expect 4 years of life (at 200 dives per year).

If for any reason the display contrast appears weak, the battery may be near exhaustion, and the computer may not continue to function correctly.

**DO NOT USE THE COMPUTER IF THE DISPLAY CONTRAST IS WEAK. RETURN IT TO SCUBAPRO FOR SERVICE.**

### 2. GENERAL

The DC-12 Decompression Computer is engineered and manufactured with reliability and durability in mind. However, as with any diving instrument, there are a few practical things to remember to ensure a long, dependable life time.

- a. Be careful to not drop the computer or allow any heavy objects (such as dive tanks) drop on the DC-12.
- b. Carry the DC-12 in a protected case inside your dive bag. A SCUBAPRO dive mask case or similar rugged plastic case works well to protect the decompression computer.
- c. Do NOT press the display front. The liquid crystal display (LCD) will become distorted and such action could cause permanent damage.



- d. Wash the DC-12 with clean, fresh water after every dive.
- e. Be sure the DC-12 is dried completely after every dive and stored in a dry location (not in a dive bag next to wet towels or wetsuit). If moisture is allowed to make a contact between the On-Sensors, the dive timer will continue to run. This may shorten the battery life.
- f. Store the DC-12 in a cool, dry place. Do not leave the computer out in the sun for very long.

## X. DESIGN SPECIFICATIONS

The DC-12 Decompression Computer is a high technology instrument, which conservatively simulates a wide range of diving profiles. The design parameters are as follows:

- Size ..... 2 1/4 " (57mm) diameter x 1 1/16" (17mm) thick
- Weight ..... 2.1 oz. (60 grams)
- Mounting ..... wrist strap or gauge console
- Algorithm ..... Hahn P-6, full decompression function  
9 compartments 5-700 minutes
- Depth accuracy ..... +/- 1.5 ft. (0.5 meters)
- Maximum operating depth ..... 295 ft. (90 meters)
- Maximum high altitude diving ..... 8,250 ft. (2,500 meters)  
13,000 ft. (4000 meters) as a depth gauge only
- Number of dives in permanent memory ..... six
- Recall dive data ..... max. depth, dive time and surf. interval
- Battery ..... lithium
- Display ..... high contrast LCD
- Computer activation ..... automatic upon immersion
- Computer shutdown ..... automatic, 4 min. 15 sec. (contacts dry)
- Operating temperature range ..... 14° F to +140° F (-10° C to +60° C)
- Temperature accuracy ..... ± 5° F (± 1.5° C)





## XI. GLOSSARY

- Algorithm:** A mathematical formula or model.
- Ambient pressure:** Pressure exerted by the surrounding environment, either in air or underwater.
- Analog display:** A graphic picture, chart or line.
- Ascent rate:** The speed of vertical ascent toward the water surface.
- Atmospheric pressure:** Pressure of surface air (14.7 psi at sea level).
- Ceiling:** The minimum depth a diver can ascend to during a decompression stop.
- Compartment:** Assumed vessel for inert gas, e.g. nitrogen, defined by its half time.
- Consecutive dive days:** Number of days diving without a break.
- Decompression:** Process of allowing pressurized gas in diver's body to be released through normal breathing while at depths prescribed by the decompression algorithm.
- Decompression stop:** The diving depth required by the decompression algorithm or tables to allow pressurized gas to be released from the body tissue.
- Desaturation time:** Amount of time for all residual nitrogen to be eliminated to bring body back to surface level pressure.
- Digital display:** Numeric data information.
- Dive profile:** The depth and time history for a dive, which includes maximum depth, bottom time and surface interval time.
- Dive Time:** From the time the diver leaves the surface to the time of returning to the surface.
- "First" Dive:** Any dive beginning with all tissues cleared of residual nitrogen (REP indicator is not displayed).

44

- Half Time:** Amount of time required for compartments ('tissues') to reach a partial pressure of dissolved gas equal to 50% of the partial pressure of the source.
- High altitude diving:** Diving in lakes above 2,300 feet (700 meters) altitude.
- In gassing:** The process of absorbing pressurized gas into body tissues while diving.
- LCD:** Liquid crystal display.
- Multiple dives:** Sequence of two or more dives, usually in the same day, made before all tissues have desaturated to ambient pressure.
- Out gassing:** The process of releasing pressurized gas from body tissue through normal breathing while ascending from a dive or on the surface.
- Repetitive dives:** Dives that are performed while the decompression model indicates Residual Nitrogen, (REP indicator displayed).
- Sawtooth dive profile:** A dive profile with alternating deep-shallow, deep dives.
- Single dive:** One dive per day.
- Surface interval:** The amount of time on the surface between dives.  
NOTE: The DC-12 will terminate surface interval timing when all tissues are desaturated to ambient pressure.
- Time to fly:** The amount of time before all body tissues are desaturated of nitrogen to a level safe to fly on pressurized commercial airlines.
- Tissue:** Substances in the body e.g. blood, muscle, fat, bone. Popular expression for the scientific term 'compartment'.

45



## XII. LIMITED ONE YEAR WARRANTY

SCUBAPRO warrants to the original consumer purchaser that for a period of one year from your date of purchase, your DC-12 Decompression Computer will be free from defects in materials and workmanship under normal use and with reasonable maintenance.

This warranty is void if your DC-12 Decompression Computer was purchased from anyone other than an authorized SCUBAPRO Dealer. To activate this warranty, it is required that the warranty registration card be completed and mailed to SCUBAPRO within 30 days of purchase.

SCUBAPRO will, at its option, repair or replace without charge any components of the DC-12 Decompression Computer which it finds defective in materials or workmanship.

To obtain warranty service, you must deliver your DC-12 Decompression Computer, together with proof of purchase, to any Authorized SCUBAPRO Dealer or to SCUBAPRO, 3105 E. Harcourt Street, Rancho Dominguez, CA 90221 or to any other SCUBAPRO Factory in the United States, Europe, or Asia. If you send the DC-12 Decompression Computer to a SCUBAPRO Factory, you must pay the shipping charges to the Factory. Parts and service must be obtained through SCUBAPRO or an Authorized SCUBAPRO Dealer.

The warranties covering the SCUBAPRO DC-12 Decompression Computer do not cover damage to the product resulting from improper usage, improper maintenance, neglect of care, or unauthorized repair.

ALL IMPLIED WARRANTIES, INCLUDING, BUT NOT LIMITED TO, THE IMPLIED WARRANTIES OF MERCHANTABILITY AND FITNESS FOR A PARTICULAR PURPOSE, ARE LIMITED TO THE DURATION OF THIS WRITTEN WARRANTY. Some states do not allow limitations on how long an implied warranty lasts, so the above limitations may not apply to you.

SCUBAPRO SHALL NOT BE LIABLE OR RESPONSIBLE IN ANY MANNER FOR LOSS OF USE OF THE PRODUCT OR ANY INCIDENTAL CONSEQUENTIAL OR INDIRECT COSTS, EXPENSES OR DAMAGES INCURRED WITH THE USE OF THE DC-12 DECOMPRESSION COMPUTER. Some states do not allow the exclusion or limitation of incidental or consequential damages, so the above limitation or exclusion may not apply to you.

No sales person, dealer or representative is authorized to make any modifications to this warranty or to make any additional warranties.

This warranty gives you specific legal rights, and you may also have other rights which may vary from state to state.